

INTERACT

Getting Started Guide

***Parker EMN
5500 Business Park Drive
Rohnert Park, CA 94928***

***Phone: 707-584-7558
Technical Support: 707-584-7558***

Copyright and Trademark Notice

Copyright © 2010 by Parker EMN. All rights reserved. No part of this publication may be reproduced, transmitted, transcribed, stored in a retrieval system, in any form or by any means, mechanical, photocopying, recording or otherwise, without the prior written consent of Parker EMN.

While every precaution has been taken in the preparation of this manual, Parker EMN and the author assume no responsibility for errors or omissions. Neither is any liability assumed for damages resulting from the use of the information contained herein. All product and company names are trademarks of their respective companies and licenses.

Product Warranty Information

Parker EMN provides top quality products through rigid testing and the highest quality control standards. However, should a problem occur with your hardware or with the software protection key, CTC's standard product warranty covers these items for 24 months from the date of shipment from CTC. Exceptions appear below:

- PowerStation backlight bulbs have a 90-day warranty.

Parker EMN
5500 Business Park Drive
Rohnert Park, CA 94928

Phone: 707-584-7558
Technical Support: 707-584-7558

- Third-party products, such as bus cards, carry the manufacturer's specified warranty.
- For all displays, image retention (burn-in) is not covered by warranty.
- Software revisions that occur within 60 days after purchase are available under warranty upon request. Please review the MachineShop License Agreement for additional software warranty information.

Should you have any questions about your application or need technical assistance, please call Parker's Product Technical Support department at 707-584-7558, 8:00am to 5:00pm, EST. You may call 1-800-C-Parker after hours for emergency assistance. See *Customer Support Services* on page 7 of this manual for more information about Parker's support products and services.

Table of Contents

Chapter 1	
Manual Overview and Support Services	1
<i>Using This Manual</i>	2
<i>MachineShop Documentation</i>	3
<i>Related Documentation</i>	5
<i>Documentation Standards</i>	6
<i>Customer Support Services</i>	7
<i>Chapter Summary</i>	7
Chapter 2	
Introducing Interact.....	8
<i>Interact Basics</i>	9
<i>Development System Requirements</i>	11
<i>Runtime System Requirements</i>	12
<i>Getting Help</i>	12
<i>Basic Interact Components</i>	13
<i>Module Descriptions</i>	14
<i>Chapter Summary</i>	15

Table of Contents

Chapter 3

Using Interact.....	16
<i>Starting Interact</i>	17
<i>Running Interact from a Network Server</i>	19
<i>Chapter Summary</i>	20

Chapter 4

Application Manager	21
<i>Overview of AM</i>	22
<i>Important Concepts</i>	23
<i>Overview of the Example Application</i>	28
<i>Creating a Project</i>	28
<i>Application Manager Interface</i>	30
<i>Adding a Module</i>	33
<i>Adding a Driver</i>	34
<i>Configuring Interact Settings</i>	35
<i>Configuring Application Settings</i>	39
<i>Experiment!</i>	41

Table of Contents

Chapter 5	
Panel Toolkit Module.....	42
<i>Overview of PTM</i>	43
<i>Overview of the Example Application</i>	44
<i>Using the Demo Device Driver</i>	44
<i>Running the Example Application</i>	45
<i>Using PTM Tools</i>	46
<i>Understanding User Levels</i>	63
<i>Adding a Panel to the Example Application</i>	67
<i>Testing the Example Application</i>	73
<i>Experiment!</i>	74
Chapter 6	
Graphics Monitoring Module.....	75
<i>Overview of GMM</i>	76
<i>Overview of the Example Application</i>	78
<i>Running the Example Application</i>	78
<i>Viewing the GMM Animation</i>	80

Table of Contents

<i>Investigating the GMM Panel</i>	81
<i>Adding a Panel to the Example Application</i>	89
<i>Testing the Example Application</i>	95
<i>Experiment!</i>	96
Chapter 7	
Alarm Management Module	97
<i>Overview of AMM</i>	98
<i>Important Concepts</i>	99
<i>Overview of the Example Application</i>	102
<i>Running the Example Application</i>	102
<i>Triggering an Alarm</i>	103
<i>Clearing Alarms</i>	107
<i>Inhibiting a Group of Alarms</i>	107
<i>Adding an Alarm to the Example Application</i>	109
<i>Testing the Example Application</i>	114
<i>Experiment!</i>	114

Table of Contents

Chapter 8	
Data Transfer Module	115
<i>Overview of DTM</i>	116
<i>Creating an Example Application</i>	117
<i>Designing a PTM Panel</i>	120
<i>Configuring DTM</i>	124
<i>Testing the Example Application</i>	126
<i>Experiment!</i>	127
Chapter 9	
Historical Trending Module	129
<i>Overview of HTM</i>	129
<i>Important Concepts</i>	129
<i>Overview of the Example Application</i>	133
<i>Running the Example Application</i>	133
<i>Modifying the Example Application</i>	142
<i>Testing the Example Application</i>	144
<i>Experiment!</i>	147

Table of Contents

Chapter 10	
Recipe Control Module.....	148
<i>Overview of RCM</i>	149
<i>Important Concepts</i>	149
<i>Overview of the Example Application</i>	152
<i>Running the Example Application</i>	152
<i>Modifying the Example Application</i>	156
<i>Testing the Example Application</i>	159
<i>Experiment!</i>	162
Chapter 11	
Machine Configuration Module	163
<i>Overview of MCM</i>	164
<i>Overview of the Example Application</i>	170
<i>Running the Example Application</i>	170
<i>Modifying the Example Application</i>	183
<i>Testing the Example Application</i>	188
<i>Experiment!</i>	189

Table of Contents

Chapter 12	
Report Module	190
<i>Overview of RPM</i>	191
<i>Important Concepts</i>	191
<i>Overview of the Example Application</i>	196
<i>Running the Example Application</i>	197
<i>Modifying the Example Application</i>	205
<i>Testing the Example Application</i>	208
<i>Experiment!</i>	209
Chapter 13	
User Program Module	210
<i>Overview of UPM</i>	211
<i>Important Concepts</i>	211
<i>Overview of the Example Application</i>	213
<i>Exploring the UPM Example Application</i>	214
<i>Modifying the Example Application</i>	218
<i>Testing the Example Application</i>	220
<i>Experiment!</i>	222

Table of Contents

Chapter 14	
Interact Network Concepts	249
<i>Overview of Interact Networking</i>	224
<i>Sharing Data Between Interact Workstations</i>	225
<i>Using Interact DDE Server</i>	227
<i>Application Capabilities Using Modems</i>	228
Appendix A Frequently Asked Questions	230

Manual Overview and Support Services

Welcome to Interact. Interact is a family of modular software products that can be easily combined and configured to meet a full-range of display-based, operator interface applications.

Chapter Contents

<u>Using This Manual</u>	<u>2</u>
<u>MachineShop Documentation</u>	<u>3</u>
<u>Related Documentation</u>	<u>5</u>
<u>Documentation Standards</u>	<u>6</u>
<u>Customer Support Services</u>	<u>7</u>
<u>Chapter Summary</u>	<u>7</u>

Using This Manual

This manual is designed to help you get up and running with Interact. It describes Interact concepts and includes example applications detailing the features of most Interact modules. You should read and understand the concepts presented in this manual prior to operating Interact.

You should read this manual from beginning to end. Pay particular attention to the concepts presented in Chapters 4 through 13. These chapters provide example applications so you can gain practical experience working with each Interact module.

After you read this manual you should reference the Windows online help files for any module you have a question on. Use this manual for reference on overall Interact concepts.

This manual is divided into the following chapters:

Chapter 1 - Manual Overview and Support Services: Presents an overview of the documentation that is provided with Interact. This chapter also provides an overview of the support services provided by PARKER.

Chapter 2 - Introducing Interact: Presents an overview of Interact and describes the individual components of the software. Describes the minimum hardware and software requirements needed to run the Interact software.

Chapter 3 - Using Interact: Presents a quick way to get started using Interact and how to run Interact from a network server. It also covers using serial drivers with Interact.

Chapter 4 through Chapter 13 - Application Manager plus all Interact modules: A chapter is devoted to the Application Manager and each Interact module. These chapters provide an overview of the module, important concepts you should know, and steps through an example application designed specifically to demonstrate the module's main features.

Chapter 14 - Interact Networking Concepts: This chapter describes networking Interact applications. Network topics include sharing data between Interact workstations, logging to and running Interact from a central location, and many other network-related topics.

MachineShop Documentation

The MachineShop package includes all of the documentation you need to install, configure, and run MachineShop. In addition, the package includes all the necessary information to develop Interact applications and MachineLogic projects. Extensive online help exists for MachineShop, Interact, and MachineLogic as well. Please review the following list to verify that you have received all necessary documentation.

Print Documentation

MachineShop is shipped with the following print documentation:

License Agreement - The License Agreement explains the terms of the MachineShop component and serves as a certificate of authenticity. This document also lists the product warranty information provided by Parker. Make sure you read and understand the information in this agreement before you install and operate MachineShop.

Customer Support Information - The Customer Support document describes how to contact Parker with your comments, questions, and concerns regarding the MachineShop product.

What's New in MachineShop - The What's New in MachineShop document describes what is new in MachineShop, Interact and MachineLogic.

MachineShop Installation Booklet - The MachineShop Installation Booklet provides step-by-step instructions on how to install and configure all the necessary components of MachineShop.

MachineShop Getting Started Guide - The MachineShop Getting Started Guide is designed to help you get up and running with MachineShop. This guide also provides instructions on how to download Interact projects from a PC to a PowerStation.

Interact Getting Started Guide - The Interact Getting Started Guide is designed to help you get up and running with Interact. Refer to the Using This Ma section on Using This Ma for a description of this manual.

Electronic Documentation

In addition to the MachineShop print documentation, the following electronic documentation is available:

Online Help Files - Extensive online help is accessible from MachineShop and Interact. The online help contains detailed information on the products and describes how to perform all

product operations. To access the online help available for a specific part of the program, press the F1 key on your keyboard.

Interact Tutorial - The Interact Tutorial is an online help file that is designed to be run on the Interact development system. This help file includes step-by-step instructions for creating example applications using the Panel Toolkit Module (PTM), the Graphics Monitoring Module (GMM), and the Alarm Management Module (AMM), which will help you become familiar with Interact. The Interact Tutorial is accessible from the MachineShop program group.

Related Documentation

In addition to the documentation that is included in the MachineShop package, you should become familiar with the following documentation:

I/O Interface Card Documentation - This documentation is supplied by the manufacturer of your I/O interface card. Please read this documentation in its entirety prior to downloading or running a MachineLogic project.

PowerStation User Guide - If you are running Interact on a Parker PowerStation, you should have received this manual. This manual explains how to configure, install, and operate the PowerStation. Please familiarize yourself with this manual prior to operating the unit.

MachineShop Shell Runtime User Guide - This manual provides instructions on how to use the MachineShop Shell to monitor and configure a PowerStation communicating with a development system running MachineShop. This includes creating and restoring backups and preparing the workstation for transfers. Please read this manual prior to downloading an Interact application from the MachineShop toolbar.

Windows Documentation - This manual assumes you have a thorough knowledge of the Windows operating system when working with Interact. If this is not the case, then refer to the documentation shipped with your operating system for details on Windows.

Documentation Standards

As you read this manual, you will notice that the following documentation standards have been followed.

1. Important terms are shown in **bold**.
2. Text to be entered from the keyboard is shown in `Courier` font.
3. Buttons, menu titles, and keyboard keys are shown in Initial Caps.
4. Indented paragraphs denote one of the following:
 - **Note** - Describes alternative approaches or issues you should be aware of while using a particular function.
 - **Important** - Contains information that needs particular attention while reading the text. Follow this information to save development time and/or minimize problems.
 - **Warning** - Contains information on safety issues. Follow this information to prevent equipment damage or personal injury.

ISO Symbols



This symbol is the International Standards Organization (ISO) symbol for Caution (ISO 3864 No. B.3.1). This symbol denotes information that could affect operation of the PowerStation if not properly followed.



This symbol is the ISO symbol for Caution - risk of electrical shock (ISO 3864 No B.3.6). This symbol denotes information that could cause personal injury from electrical shock or damage to equipment if not properly followed.

Customer Support Services

Parker welcomes your thoughts and suggestions on our products and services. You can contact Parker by telephone, email, or fax. You can also visit Parker on the World Wide Web to learn the latest about Parker hardware, software, and customer support services.

- Telephone: 707-584-7558
- E-mail: emn_support@Parker.com
- World Wide Web: <http://www.Parkermotion.com>

Parker recognizes that every customer and every application has different support needs, so Parker offers a variety of support services designed to meet those needs.

Product Technical Support

The Product Technical Support department welcomes any question that might arise as you develop or run your applications. We offer complimentary support for any customer, whether you are an end user, original equipment manufacturer (OEM), system integrator, or distributor.

If you have a question about MachineShop, Interact be sure to complete the following steps before contacting the Product Technical Support department:

1. Check the Readme files installed with the software. These files provide general information about the release.
2. Consult the appropriate documentation and other printed materials included with MachineShop and Interact.
2. Check the online help. MachineShop and Interact each have extensive online help facilities that cover all aspects of the product.

If you cannot find a solution, contact the Product Technical Support department for help. Support lines are open during normal business hours, Monday through Friday, 8:00am to 5:00pm EST. You may call 1-800-C-Parker after hours for emergency assistance.

Chapter Summary

This chapter has provided a general overview of the documentation that is provided with Interact as well as the supporting documentation that you may find useful as you develop Interact projects. This chapter has also provided an overview of Parker's support products and services.

In the next chapter you will learn about the Interact user interface as well as the system requirements for running Interact.

Introducing Interact

Interact provides you with a reliable and efficient method of controlling your machines. It is part of the MachineShop development environment, which also includes MachineLogic. Information on MachineShop and MachineLogic is provided in the Getting Started Guides for each application. This chapter provides an introduction to Interact and its components.

Interact is a modular software family that can give you all the functionality you need, from control panel replacement to historical trending and networking. Interact makes it easy to develop, maintain, and run your own applications. Pre-configured tools and screens as well as comprehensive online help files make it easy to develop the perfect application for your system.

Please review this manual and all other documentation included with Interact before configuring an application.

Chapter Contents

<i>Interact Basics</i>	9
<i>Development System Requirements</i>	11
<i>Runtime System Requirements</i>	12
<i>Getting Help</i>	12
<i>Basic Interact Components</i>	13
<i>Module Descriptions</i>	14
<i>Chapter Summary</i>	15

Interact Basics

Welcome to Interact. Interact is a family of modular software products that can be easily combined and configured to meet a full-range of display-based operator interface applications. Interact software can be used in systems such as:

- Machine Control Stations with display-based panel replacement, graphics, and alarming, which are alternatives to traditional hardwired control panels
- Operator Interface Workstations with recipe management, historical trending, and data logging in conjunction with panel replacement functions
- SCADA or Supervisory Control Workstations with comprehensive reporting, networking, and the ability to send factory floor information to other computing environments like MIS

Operating Environments

Interact has two distinct operating environments: development and runtime. The development environment is a 32-bit application designed to run under Windows 95, Windows 98, Windows NT or Windows XP, while the runtime environment runs under MS-DOS®. This means you can take advantage of both the ease-of-use of the Windows graphical user interface in the development environment and the high-speed efficiency, reliability, and cost-effectiveness of the DOS runtime environment.

Development Environment

The development environment allows you to create your operator interface application. It provides an integrated development environment for creating control panel screens and configuring module and driver settings. Development modules and drivers are supplied as Windows Dynamic Link Libraries (DLLs) which you install using the Interact Setup program according to your application's needs.

Each module and driver requires specific configuration for the user application. For example, graphics must be drawn and alarm text must be entered and tied to an I/O trigger point. Whether you are drawing a push button or identifying which I/O point to be logged, all configuration information about the application is performed in the development environment.

Runtime Environment

The runtime environment simply uses the screens and information that were created in the development environment and communicates with the control equipment to monitor and turn I/O points on and off. The modules perform their specific tasks according to how they were configured in the development environment. For example, while Interact is running, the user could acknowledge an alarm, and a date and time stamp could be assigned and logged, if these functions were configured in the development environment.

The runtime environment runs under MS-DOS. The runtime versions of the Application Manager, modules, and driver programs allow you to acquire data from controllers and view module and driver screens. During runtime, Interact runs in protected mode and uses extended memory, eliminating the limitations of DOS real mode.

Important The runtime environment is designed to run exclusively under MS-DOS. To test the functionality of your application, you can select the Run Interact command from the Run menu on the Application Manager menu bar, but for better performance and improved reliability, you should exit Windows entirely whenever you run an application in an actual production environment.

The runtime environment consists of two modes of operation: Program Mode and Run Mode. Programmable controllers typically provide a program mode for entering and editing ladder logic rungs and a run mode for executing these rungs. Similarly, Interact's Program Mode allows you to change driver configuration, Interact Settings, and Application Settings without having to return to the development environment. Run Mode lets you view operating module screens using data collected by the drivers.

Development System Requirements

The development system is the computer you plan to use to create and manage your Interact applications. This computer will not be used to run the applications that you create. Instead, you will use this computer to manage your applications to and from a PowerStation that will be used to run your applications. The PowerStation is referred to as the *runtime system* throughout this manual.

The Interact development environment is a 32-bit Windows application designed to run in Windows 95, Windows 98, Windows NT or Windows XP. To achieve acceptable performance, your hardware platform should meet the **minimum** requirements below.

Hardware Requirements

Your development system must meet or exceed the following system requirements in order for Interact to perform as intended:

- Processor: Pentium 133MHz / 300 MHz (Windows XP Systems)
- Memory: 24MB RAM (Windows 95/98 systems)
- Memory: 32MB RAM (Windows NT systems)
- Memory: 256MB RAM (Windows XP systems)
- Fixed Storage: 50MB of free hard disk space
- Removable Storage: CD-ROM drive
- Input Devices: keyboard and Microsoft compatible mouse
- Video: 800 x 600 resolution, 256 colors
- 10MB Ethernet network interface card or serial port

Software Requirements

Your Interact development PC requires the following software in order to develop Interact applications:

- Operating System: Windows 95 4.00.950B (OSR2), Windows 98 or Windows NT 4.0 SP3

Interact: Version 7 or later

Installing the Software

Refer to the *MachineShop Installation Booklet* for step-by-step instructions on how to install and setup the Interact software components.

Runtime System Requirements

The runtime system is the PowerStation you plan to use to run your Interact applications. This computer will only be used to run the applications you create. You will develop your applications on a development system and download them to this computer.

The Interact runtime environment runs under MS-DOS. The Interact runtime environment runs in protected mode and uses extended memory, eliminating the limitations of DOS real mode. Interact is only offered bundled on Parker's PA and PA2 families of PowerStations. The PA and PA2 families have been designed to provide optimum system performance for Interact runtimes.

Installing the Software

Refer to the *MachineShop Installation Booklet* for step-by-step instructions on how to install and setup the Interact software components.

Getting Help

Help is available if you have any questions about the features of Interact or need additional information. For print documentation, read the Getting Started Guide and look in the table of contents or index. For online documentation, select Help from the Interact toolbar and view the help contents or perform an index search.

Before consulting a Parker support representative, we suggest you look for help in this Getting Started Guide or search the online help. If you are unable to find the information you need, call Customer Support for assistance. For more information about available support services or how to contact Parker Customer Support, see Chapter 1.

Basic Interact Components

There are three basic components to the Interact software: the Application Manager, modules, and device drivers. The Interact architecture is illustrated below:

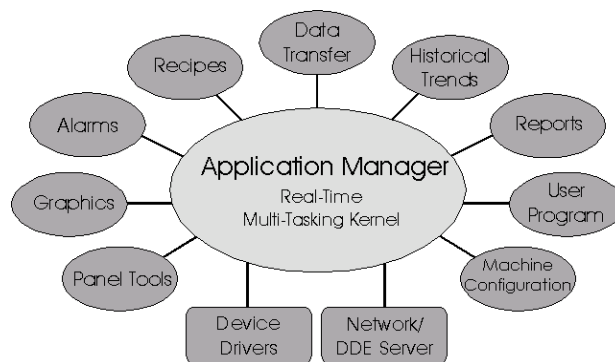

- **The Application Manager** represents the core of the Interact software. In the development environment, it provides a framework to manage the various aspects of the application, such as the modules and device drivers. In the runtime environment, the Application Manager is a real-time, multitasking kernel that controls the flow of data from the modules to the drivers. Its multitasking capability, which is required for high-performance operator interfaces, allows data to be processed simultaneously from various modules and device drivers. It represents the heart of Interact that keeps the data flowing freely.
- **The Application Modules**, also referred to as modules, are optional components. Modules provide specific operator interface functionality, such as graphics, alarming, recipe management, etc. Knowing that requirements vary from application to application, Interact's modular architecture allows you to purchase the products that support all the functionality needed for various applications. The user can also choose just the functions or modules needed for each specific application. Also, with this modular architecture, modules can be easily added in the future if the application requirements change.
- **The Device Drivers** are the communication components of the software. They handle the reading and writing of data to and from Interact and control devices, such as PLCs, drives, and motion controllers. Interact currently supports over 45 different device drivers, which include all of the major PLC brands.

In addition, Interact supports customer-developed, device drivers with the Software

Development Kit (SDK). This kit allows the user to develop interfaces so Interact can communicate to devices which are not supported by the standard product. Interfaces for bar code readers, vision systems and pagers have all been developed using the SDK.

Module Descriptions

Panel Toolkit Module (PTM)

Use PTM to construct a screen-based equivalent of traditional operator control panels. A library of over 30 panel tools modeled after standard hardwired devices is available. Various tools are listed below.

- Lighted Push Button
- Numeric Display
- Panel Meter
- Real-time Line Trend
- Bar Graph
- Multi-state Indicator
- Slide Potentiometer
- XY Plot
- PID Faceplate
- ASCII Message Entry

Graphics Monitoring Module (GMM)

Use GMM to add free-form, animated graphics to PTM panels using CAD-like, graphic tools. Animation actions can be based on either discrete or analog values and include changes in size, color, location, orientation, and visibility. The ability to import the most common graphic formats is also supported by GMM. These formats include BMP, JPG, TIF, AutoCAD DXF, WMF, and PCX.

Alarm Management Module (AMM)

Use AMM to define alarm conditions and specify corresponding reporting, logging, and corrective actions. Alarms can be grouped for enhanced, alarm control and prioritized using five, color-coded, priority levels.

Recipe Module (RCM)

Use RCM to download, upload, edit, and store recipes online. A log of recipe alternatives is automatically stored.

Machine Configuration Module (MCM)

Use MCM to download, upload, edit, and store groups and lists online. These groups and lists run your processes, providing the settings and functions to produce your product. This module also keeps an automatic log of all changes in lists and groups and all activity.

Data Transfer Module (DTM)

Use DTM to exchange data at high speed between different control equipment by passing information among multiple, Interact device drivers.

Historical Trending Module (HTM)

Use HTM to view logged data online in tabular or line trend format. You can also view data off-line via popular computer packages.

Report Module (RPM)

Use RPM to create free-form reports that can be reviewed online, printed, and downloaded to a network or disk. Report functions include value minimum/maximum tracking, event counting and timing, and row/column sum and average.

User Program Module (UPM)

Use UPM to easily add your own features to an Interact application with a user-written, terminate-and-stay-resident (TSR) program that shares data with Interact.

Networking

Interact provides a NetBIOS, high-speed LAN that allows real-time data to be shared among multiple, Interact stations. The NetBIOS interface is implemented using the NetBIOS driver. This driver works with all major networking topologies and provides remote monitoring and control functions, the ability to share log files, and a connection between distant remote stations via modem.

DDE Server

Use the DDE Server to connect Interact applications directly to Windows applications via a NetBIOS-compatible LAN. The DDE Server is used with Interact's NetBIOS, network driver and allows any DDE-enabled, Windows application to exchange data with any Interact workstation.

Chapter Summary

In this chapter you have learned about the hardware and software components for Interact Development and Runtime.

In the next chapter, you will learn how to start Interact development and runtime.

Using Interact

Before you begin creating and building Interact applications, you need to understand how to get up and running with Interact.

This chapter provides information on starting the Interact Development and Runtime components. It also describes how to run Interact from a network server. In addition, this chapter covers using serial drivers with Interact.

Chapter Contents

<i>Starting Interact</i>	17
<i>Running Interact from a Network Server</i>	19
<i>Chapter Summary</i>	20

Starting Interact

This section describes how to start Interact development and Interact runtime.

Starting Interact Development from MachineShop

Interact must be started from MachineShop. MachineShop is the foundation of your Interact software and is used to create, manage and transfer your projects to and from your runtime system. Once a project is created and opened in MachineShop, you can then launch Interact from the MachineShop toolbar. The toolbar opens Interact with the proper application ready for development.

See the *MachineShop Getting Started Guide* for a complete discussion on how to use MachineShop.

To open Interact development, follow these steps:

1. Start MachineShop and open your project.

Use the MachineShop online help for assistance.

2. Click the **Interact** button on the MachineShop Toolbar or select **Interact** from the Tools menu.

The Application Manager window appears with the proper application ready for development..

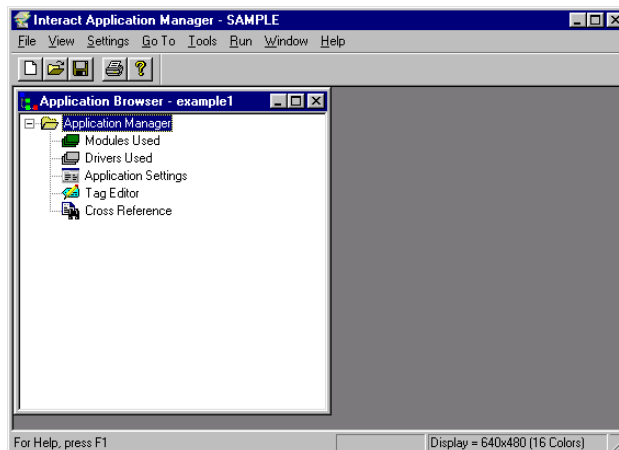

Starting Interact Runtime

You may start the Interact Runtime from Interact development or from MS-DOS.

Start Interact Runtime for Interact Development

To start Interact runtime from Interact development, follow these steps:

1. Start MachineShop and open your project.
2. Click the **Interact** button on the MachineShop Toolbar or select **Interact** from the Tools menu.

The Application Manager window appears with the proper application ready for development.

Note If you need to open another application, select the **Open Application** command from the File menu. The Open Application dialog box appears. Select the name of the application you want to open and click **OK**.

3. Select the **Run Interact** command from the Run menu.

Interact opens an MS-DOS window and begins running the MS-DOS version of Application Manager. The screen that appears in the window depends on the options you select from the Startup Mode group on the General page of the Application Settings property sheet.

Start Interact Runtime from MS-DOS

To start Interact runtime from MS-DOS, follow these steps:

Important Before starting Interact on a Windows NT system, you must have MS-DOS or Windows 95 installed with dual-boot capability, and you must reboot into MS-DOS mode prior to completing the steps below.

1. From the MS-DOS prompt, type **c:** (if necessary, substitute your drive letter for c:).
2. Press **Enter**.
3. Type **cd\Interact\am** (if necessary, substitute your path for \Interact).
4. Press **Enter**.
5. Type **am**.
6. Press **Enter**.

The Application Manager runtime display appears or the application chosen as the Startup

Application is displayed. The Application Manager runtime display is shown below.

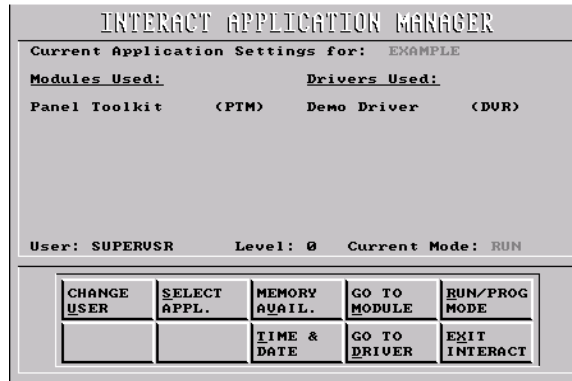

Running Interact from a Network Server

Interact software is network aware, meaning you can run it from any logical drive. This allows you to store Interact files and the Interact applications you create on one centralized server for both development and runtime. This may be done using the Interact runtime environment variables: **Interact** and **Interact_files**. These settings control the location of the Interact program files (Interact) and the application files (Interact_files).

Important Before you can run Interact from a logical drive, you must have MS-DOS client software installed and configured with the proper drive mapping using the environment variables listed above. This requires an in-depth knowledge of networking and access to proprietary files that CTC is unable to provide. Consult your network supervisor or an experienced network technician for more information about configuring your local area network.

Centralizing of program and application software makes file management and software upgrades fast and simple because all Interact program and application files used throughout the facility are located in the same place. The picture below illustrates two Interact stations running off the same network server.

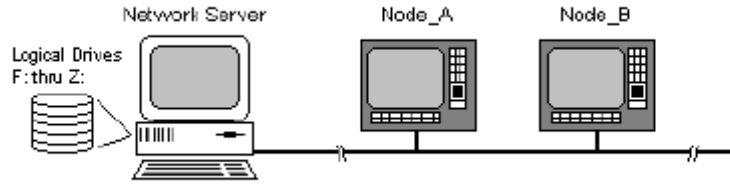

Node_A and Node_B might have environment variables as:

```
set interact=f:\interact
```

```
set interact_files=f:\interact\appfiles
```

These environment settings may be set to any logical path and may be stored in the workstation's autoexec.bat file or in a batch file entered at startup.

Chapter Summary

In this chapter you have learned how to start Interact and how to run from a network server.

In the next chapter, you will learn about the Interact Application Manager (AM).

Application Manager

The Application Manager (AM) is essentially the framework of Interact that holds together the modular components of the product. All Interact applications, whether in the development environment or the runtime environment, require AM. This chapter discusses AM and includes an example of how to create and configure an application.

Chapter Contents

Overview of AM	22
Important Concepts	23
Overview of the Example Application	28
Creating a Project	28
Application Manager Interface	30
Adding a Module	33
Adding a Driver	34
Configuring Interact Settings	35
Configuring Application Settings	39
Experiment!	41

Overview of AM

AM consists of two programs, one for the development environment and one for the runtime environment. These programs are described in the sections that follow.

AM for the Development Environment

AM for the development environment is a 32-bit, Windows application designed to run in Windows 95, Windows 98, Windows NT or Windows XP. This program allows the user to create applications, select and configure modules and device drivers, set system settings, and run utilities.

In the development environment, AM works in conjunction with the modules and device drivers to create runtime files to be executed in the runtime environment. AM also supports system functions and utilities. For example, utilities such as the Tag Editor and the Cross Reference Utility are available through AM.

AM for the Runtime Environment

AM for the runtime environment is an MS-DOS program that is used to execute the files created in the development environment. It is a real-time, multitasking kernel that manages the flow of data within Interact. This multitasking capability allows the data to be processed by the multiple modules simultaneously, which is essential for Interact to provide the performance required for most operator interface applications.

In the runtime environment, all data flows through AM. The device drivers communicate to the control equipment; AM receives the data from the device drivers; then, AM transfers the data to the modules that require specific I/O addresses. AM also allows certain device driver options to be changed, such as baud rate, but I/O configuration can only be set in the development environment.

In summary, AM manages all aspects of the application whether in the development environment or the runtime environment. The figure below illustrates the relationship between the modules, drivers, and AM.

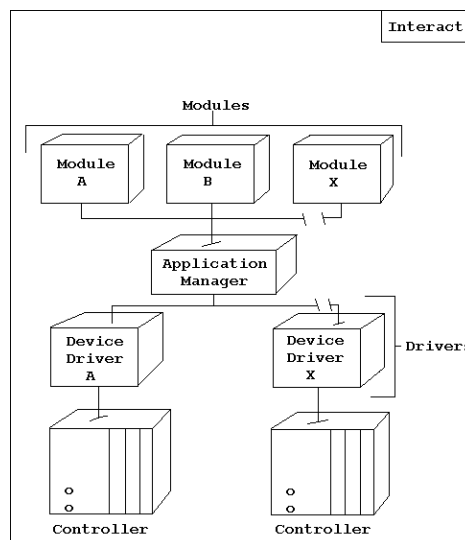

Important Concepts

The Application Manager (AM) is the foundation of Interact; therefore, you must understand the following concepts before using Interact for the first time.

Application

A group of Interact module programs and driver programs that you configure to perform a specific workstation task.

Application Manager

The foundation of the Interact product. Application Manager provides the link between Interact modules and drivers and allows you to perform several basic functions:

- Specify the application name
- Select which modules and drivers to use for your application
- Switch between the development environment and the runtime environment for designing and operating your workstation

Password Settings

Interact provides a method of runtime security in the form of user levels. The level of security depends on who is currently operating the system. Each operator is assigned a user name, a unique password, and a user level.

The user name is a name referencing the operator and can be any printable ASCII string up to 12 characters long. The password is a unique set of characters associated with the user name that enables the user access to the system. The password can contain up to 15 alphanumeric characters.

User levels are active in the runtime environment only. They control the operator's access to certain functions. For example, you may exclude the operator from viewing specific PTM panels depending on the user level. Interact supports six user levels numbered from 0 to 5. User level 0 is the highest user level, offering the most privileges; user level 5 is the lowest user level, offering the least privileges.

Restrictions on AM runtime functions are as follows:

- User level 0 - The operator has access to all application, module, and driver functions.
- User level 1 - The operator is restricted to Run Mode functions. The operator may not access Program Mode functions or exit from Interact.
- User level 2, 3, and 4 - In addition to level 1 restrictions, the operator may not select an application.
- User level 5 - In addition to the restrictions for levels 1 through 4, the operator may not view driver screens.

Address References

The module screens you design for your Interact workstation may contain input and output tools. The operator monitors data from the controller with output tools and uses input tools to modify data in the controller. When you configure a tool, you identify the data that the tool will monitor or change. Output references identify the data to monitor. Input references identify the data to change.

Interact expects all address references to start with the name of the device driver that is attached to the controller containing the referenced item. Device driver names can have up to six characters, but most driver names are four or five characters long.

Throughout this manual, the generic name DVR is used as the device driver name. The device driver name is separated from the rest of the reference by the backslash (\) character (dvr\`address string`).

Controllers of varying models and vendors have different methods of addressing. The address string format you use depends on what is expected by the named device driver. Refer to the online help file of the device driver you are using for specific information on the device driver name and address string format.

Throughout this manual, we have adopted a standard method of showing address references, as listed below:

DVR\`DN`:`WORD`.`BIT`

DVR	= device driver name
\	= device number delimiter
DN	= device number
:	= word delimiter
WORD	= word address
.	= bit delimiter
BIT	= bit within word (0 - 15 decimal)

Below is a list of address examples:

dvr\1:200 = driver "dvr" / device #1 / word 200

dvr\2:400.5 = driver "dvr" / device #2 / word 400 / bit 5

dvr\12:59.15 = driver "dvr" / device #12 / word 59 / bit 15

This format is used for illustrative purposes only. The actual address reference format you will use depends on the device driver and is described in the device driver online help file.

Link Variables

The Interact link driver enables data to be transferred between Interact modules without storing the data in the controller. This is done using link variables (data stored in Interact's Link Variable Memory) made available to all Interact modules.

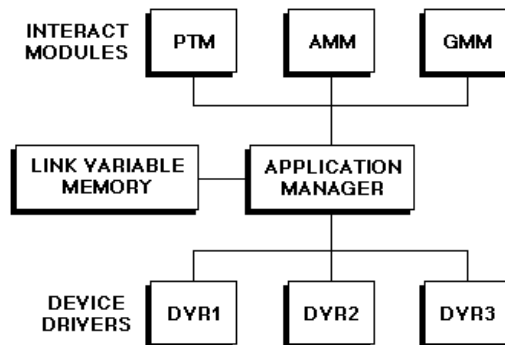

To define a link variable, you assign a special address reference. Address references for link variables are similar except for the following:

- The driver name is always “LINK.”
- There is no device number.
- The link variable is always a whole word or a discrete value—there is no bit reference.

A typical reference for a link variable looks like this:

```
LINK\BATTERY_LOW
```

Decoding Address References

When the Application Manager decodes an address reference it first looks for the device name, which is everything before the backslash (\).

```
LINK\BATTERY_LOW
```

If the device name represents a controller, the data will be written to (input) or read from (output) a specific location in the controller memory. If the device name represents a link variable, the data will be stored to or retrieved from a specific location in Interact's Link Variable Memory.

Reserved Link Variables

The Application Manager and some Interact modules have link variable names reserved. The link variables reserved for each module are described in the help file for that module and are summarized in the Link Variable List located in the Application Manager help file. For example,

the Application Manager reserves the following link variables:

- LINK\RELAY is a variable used with Interact running on a PowerStation. It is used to actuate an external relay connected to the PowerStation (a discrete input).
- LINK\BATTERY_LOW is a variable used with Interact running on a PowerStation. It is used as an indication to the user that the PowerStation's internal battery is low and needs to be replaced (a discrete output).
- LINK\USER_LEVEL is a variable used to change the user level in Run Mode. A supervisor can use an analog input tool to change the user level without entering a password.
- LINK\SCREEN_SAVER is a variable that allows you to monitor the status of a PowerStation's screen saver.

Link Variable Example

Assume that you want to generate an alarm when the Application Manager detects a low battery condition. This is done as follows:

1. The Application Manager detects the low battery condition.
2. The link driver sets link variable LINK\BATTERY_LOW true (i.e., writes a 1 to this memory location).
3. The Alarm Management Module is configured to monitor this variable address. When it detects a 1 at location LINK\BATTERY_LOW, it generates the configured alarm response.

Tag Editor

The Interact Tag Editor is a program that enables you to create a list of tag names and their associated address references. A tag name can then be entered instead of an address reference string when you are prompted for an address during module configuration.

Note Although the use of tags simplifies the configuration process, it can affect Run Mode performance. Starting Run Mode and switching between panels takes more time since Interact must search the Tag List for the address reference that corresponds to each tag. If you have sufficient system memory, you can set the Tag Storage in Run Mode parameter in the Tag Editor Settings dialog box to Load All into Memory to improve performance.

Tag Names

A tag name is a name used in place of a controller-specific address reference string. You can also combine tag names with controller-specific references. Tag names make your application more flexible and usable in other control systems. Tag names may be up to 30 characters long (this does not include the @ character).

Note Every tag name must begin with the @ character. Tag Editor automatically inserts the @ for you if you check the Include @ in Selection check box in the Tag Editor Settings dialog box.

An example of a tag name is as follows: @BUTTON. This tag name could be used to reference the address DVR\1:1. Any tool assigned the @BUTTON reference would refer to address DVR\1:1 in your controller.

The Tag Editor saves tag names in the INTERACT.TAG file that resides in your application's subdirectory. There can only be one tag file per application. Interact searches for the tag file each time it enters Run Mode. If a tag file exists and the Use Tags in Run Mode check box is checked in the Tag Editor Settings dialog box, the Tag Editor replaces all module item address references that have been assigned a tag name with the associated tag name. If a tag file does not exist, Interact assumes normal address references have been used.

Cross Reference Utility

The Interact Address Cross Reference Utility (CRU) enables you to generate a Cross Reference Report of address references for a specific application.

Using the Cross Reference Utility

To run the CRU, follow these steps:

1. Select the **Cross Reference** command from the **Tools** menu.

The Cross Reference dialog box appears.

2. Enter an address reference or tag name followed by a file specification.

The CRU determines what drivers are being used in it and what their names are. Application Manager (AM) scans the pertinent files within the application and performs a search for all address references, tags, and link variables. AM then includes these references in a report that lists the references alphabetically and by file type.

Viewing the Cross Reference Report

You can view the report in one of two formats: by file or by module. Viewing by file will list the address references, matching your search criteria, on a file-by-file basis. Viewing by module will list the address references, matching your search criteria, on a module-by-module basis.

Contents of a CRU Report

The CRU report consists of the following information.

1. The report header that contains the following information:
 - The date and time the report was generated
 - A legend listing the names of the drivers contained in the application files

- The total number of files and references
- 2. A list of references arranged alphabetically with the file or files the references are found in, along with the number of times they appear in the file
- 3. A list of files arranged by module, each listing the references it contains

Additional References That May Appear in a Report

In addition to the information listed above, the CRU report may also include the following references:

- All addresses assigned to tools, whether they are visible on the screen or not. For example, if a bar graph has four address references assigned for the different bars and the tool is resized on the screen to only show two bars, the CRU will still report all four addresses, even though only two appear on the screen.
- The Data Transfer Module (DTM) enables you to assign a starting address for a block of addresses. The CRU utility will only report the starting address for a block.

Overview of the Example Application

The following sections provide hands-on experience with creating and configuring a project and application using MachineShop. AM has no pre-existing application that is shipped with Interact. You must create the project and application yourself. In this example you will learn to do the following:

- Create a project and application using MachineShop
- Observe the menu bar and toolbar
- Navigate Interact
- Add Modules and Drivers
- Select an existing application
- Configure Interact settings
- Configure application settings

Creating a Project

MachineShop provides a New Project Wizard to guide you through the process of creating a project.

To create a project and application using MachineShop, follow these steps:

1. Start MachineShop if it has not been started already. The MachineShop toolbar appears at the top of your desktop.

2. On the File menu, click **New Project**, or click the **New Project** button on the toolbar.

The New Project dialog box appears.

3. Type a project name, a project description, and click the **Interact** box.
4. Click **OK** to accept the changes and begin the New Project Wizard.
5. Follow the instructions provided by the New Project Wizard to finish creating the project.

The New Project Wizard will ask you to enter an application name and to select the modules and the driver(s) that will be used in the application. Enter or select the following options:

- application name = **amexamp**
- Module = **Panel Toolkit Module (PTM)**
- Driver = **Demo Driver (DVR)**

You can add additional Modules and drivers from Interact. Instructions to add Modules and drivers is discussed later in this chapter.

6. When the New Project Wizard is finished, click the **Interact** button on the MachineShop Toolbar to start Interact.

The Application Browser appears, with the application name you entered appearing in the Application Browser title bar.

The Application Manager window is shown below.

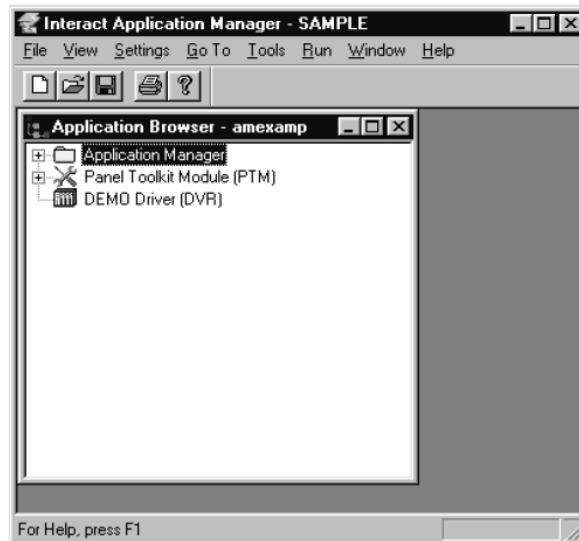

Application Manager Interface

This section describes the Application Menu Bar and Toolbar as well introduces you to the major components of the AM development environment.

Using the Menu Bar and Toolbar

The Application Manager Menu Bar and Toolbar are shown below. Each selection is described in the following paragraphs.

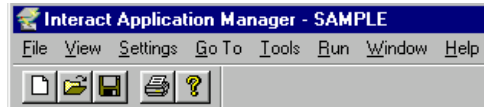

File Menu

The File menu is the main menu in AM. It includes the commands for managing applications. You can create new applications, open and save existing applications, and set application properties.

View Menu

The View menu includes the commands for customizing the program window. Each command acts as a toggle switch: when the command is active, a check mark appears next to the command name.

Settings Menu

The Settings menu includes the commands for configuring and customizing the application.

Go To Menu

The Go To menu allows you to switch to any other module or driver you have included in the current application. When you open the Go To menu, a list of the available modules and drivers appears.

Tools Menu

The Tools menu allows you to access the Cross Reference utility and the Tag Editor utility.

Run Menu

The Run menu allows you to enter the Interact runtime environment.

Window Menu

The Window menu includes the commands for controlling windows and icons that appear in the program window. If you are familiar with Windows applications, many or all the commands will be familiar to you.

Help Menu

The Help menu includes the commands for finding help on AM. The Contents command opens the AM help window. From here you can browse for the desired information. The How to Use Help command provides general information for using and navigating Windows online help.

You can also view the Interact Help Contents by selecting the Introduction command or the Interact Tutorial by selecting the Tutorial command.

Toolbar

The Toolbar provides quick access to the commands you use most often in the Application Manager (AM). The default position for the Toolbar is along the top of the AM program window, but you can drag the Toolbar to another location. Each of the tools in the Toolbar also appears on one of the eight AM menus.

Navigating Interact

The Interact Application Manager, the modules, and the drivers are Windows-compatible applications. This means that they adhere to the standards set by Microsoft for Windows applications. The following paragraphs introduce you to the main components of the AM development environment. If you are already familiar with Windows applications, much of this information may be familiar to you.

Application Browser

The Application Browser is a window that displays Interact applications and their components hierarchically. Icons appear at each level of the tree, and dashed lines further define the hierarchy. The Application Browser is designed to provide you a graphical way to manipulate Interact applications, but there are also menu commands available that you can use to accomplish the same tasks. An example of the Application Browser appears below.

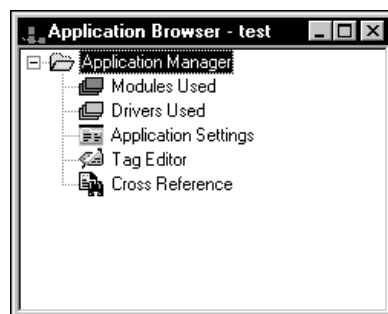

You can navigate the Application Browser with the mouse or keyboard. If you are using the mouse, select the desired levels to expand or collapse the tree. If you are using the keyboard, use the Up and Down arrow keys to move to the desired level of the tree, and press the Right and Left arrow keys to expand or collapse a level. Levels that can be expanded have a plus (+) to their left, those that can be collapsed have a minus (-) to their left, and those with no levels have no sign at

all.

Workspace

The workspace is the area just below the menu bar and Toolbar. This is the main working area of the application. The Application Browser is located here as well as any open windows. You can move and resize the Application Browser and the windows to occupy some or all the workspace. However, you must stay within the boundaries of the workspace. You do not actually enter and modify parameters in the workspace itself but in windows located in the workspace.

Windows

Windows appear throughout each of the Interact modules. Windows allow you to view and edit information as well as view the content and properties of objects. Windows also display palettes of controls, parameters to complete commands, or messages to inform you about the status of the program. Two types of windows generally appear in most Windows-compatible applications: primary windows and secondary windows.

When in Windows-compatible applications, you do most of your viewing and editing in primary windows. The Interact Application Manager window is an example of a primary window.

You specify parameters or options in secondary windows. They can also contain specific details about the objects or actions in the primary window. The Interact Application Browser is an example of a secondary window.

Dialog Boxes and Property Sheets

Dialog boxes and property sheets appear throughout each of the Interact modules. These objects are similar in that they both provide an exchange of information between you and the application. Dialog boxes and property sheets generally appear after you choose a particular menu command or command button. Menu commands or command buttons that have dialog boxes or property sheets associated with them are followed by an ellipsis (...).

Dialog boxes and property sheets differ from one another in the way they present controls and information. Dialog boxes present all of the controls and information in one place and are intended to obtain additional information from you that is needed to complete a particular task.

Property sheets display the properties of an object that are accessible to you. They condense what may be found in several dialog boxes into a series of tabbed pages that contain controls and information.

Adding a Module

When you need to add a module to an application, use the Modules Used icon on the Application Browser or the Modules Used command on the Settings menu. You can add as many modules to your application as system memory allows.

To add a module to an application, follow these steps:

1. Double-click the **Modules Used** icon in the Application Browser.

The Modules Used dialog box appears as shown below. If you selected the PTM module when you created the application, it should be listed in the Modules Used By list.

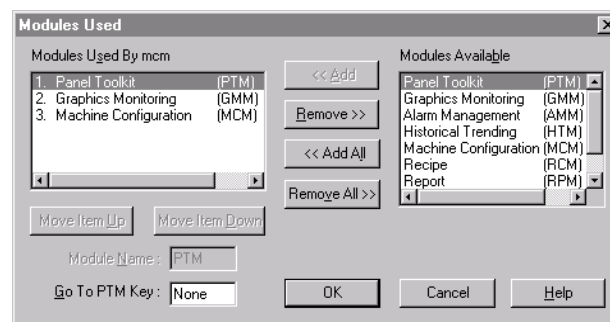

2. Add RPM to

this application:

- a. Click **Report (RPM)** in the Modules Available list.
 - b. Click **Add**. RPM is now listed in the Modules Used By list.
3. Click **OK**.

RPM appears in the Application Browser Window.

Adding a Driver

When you need to add additional drivers to an application, use the Drivers Used icon on the Application Browser or the Drivers Used command on the Settings menu. You can add as many drivers to your application as system memory allows.

To add a driver to an application, follow these steps:

1. Double-click the **Drivers Used** icon in the **Application Browser**.

The **Drivers Used** dialog box appears as shown below:

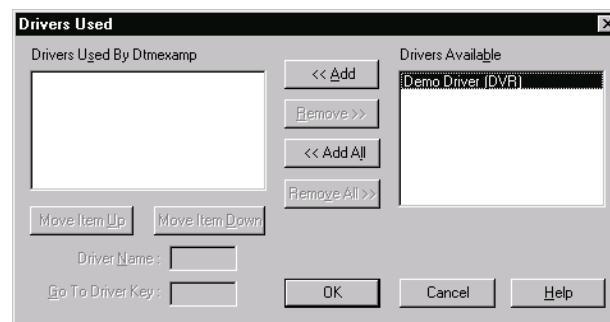

2. Drivers are added to applications the same way as Modules. Add the
 - a. Click the appropriate from the Drivers Used list.
 - b. Click **Add**. The driver is now listed in the Drivers Used By list.
3. Click **OK**.

The driver will appear in the Application Browser window.

Closing an Interact Application

This portion of the example is complete. You do not need to save this example. In the next section, you will be running the PTM example application and making changes to it.

To close an Interact Application, follow these steps:

1. Open the File menu from the menu bar.
2. Click on **Close Application**.

This will close the Application Browser for your current application.

Configuring Interact Settings

In this section you will make changes to the Interact Settings property sheet. Changes made to the Interact Settings property sheet affect all Interact applications. For detailed information on each parameter see the Application Manager help file.

You will select the PTM example application shipped with the PTM module, change several Interact settings, and observe the changes in Run Mode. If you do not have PTM, just read through the steps below.

Important You must remember to change the Interact settings back to their previous state or when you run the PTM example in the next chapter it will not work properly.

To change Interact Settings, follow these steps:

1. On the **File** menu, click **Open Application**.

A list of available projects appears.

2. Double-click the **APPFILES** folder.

The APPFILES folder opens.

3. Click **Example** and then click **OK**.

The Application Browser appears with the Example application loaded.

4. On the **Run** menu, click **Run Interact**.

5. Click on **Yes** in the **Save** dialog box.

You enter the Interact Run Mode. The PTM panel appears as shown below:

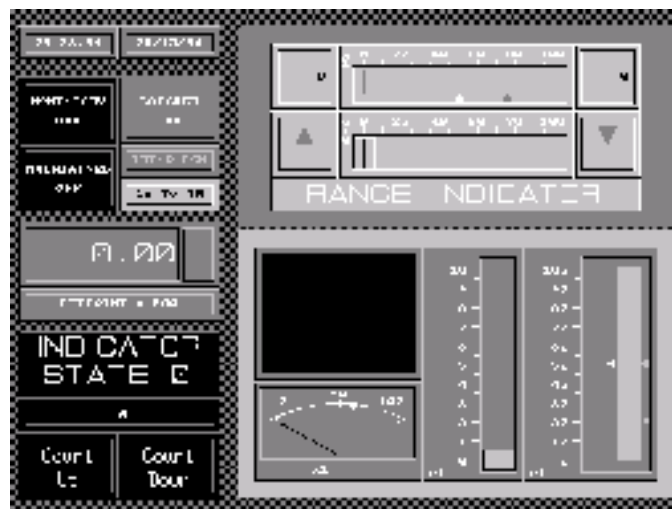

6. Press the **F10** function key.

The Application Manager Run Mode menu is displayed. You will change this so that function key F9 will display the Application Manager Run Mode display. The Screen Saver is not yet activated. Now return to the Interact development environment.

7. Click **Exit Interact**; then, click **Accept**.

You are returned to the Interact development environment.

8. On the **File** menu, click **Interact Settings**.

The **Interact Settings** property sheet appears as shown below:

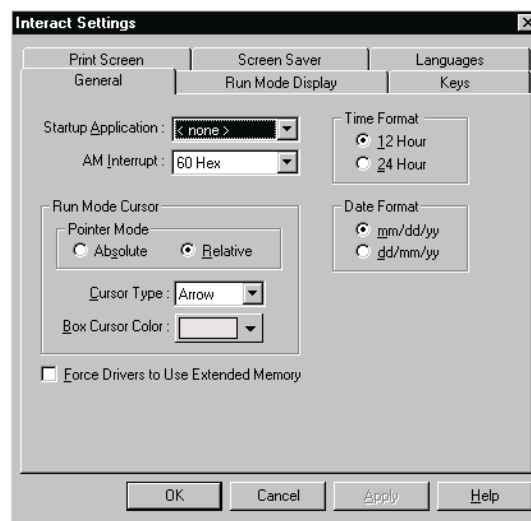

The General page is displayed once the Interact Settings property sheet appears.

9. Select the **Run Mode Display** page of the **Interact Settings** property sheet.

Use this page to configure the Run Mode display type, AM menu color, and the blinking colors.

10. Click the **Display Type** box, and select **Plasma** for the display type.

The display type you select allows you to select colors that are appropriate for the target platform. The Interact color scheme changes the next time you enter Run Mode.

11. Select the **Keys** page of the **Interact Settings** property sheet.

Use this page to assign the default Selection Key and keys for special functions such as Go to AM, next and previous module, print screen, and abort print.

You may assign any key on the keyboard except the arrow keys, but do not terminate your entry by pressing the Enter key. Ctrl, Alt, and Shift key combinations are also valid, but the Shift key is ignored when you press it in conjunction with the A through Z keys.

If you want a key to be undefined, press the Delete key at the prompt. The setting will be shown as None. When you have selected the setting you wish to change, simply press the key or key combination you want to use. For example, Ctrl+F5 will be shown as c-F5 (0/98).

12. Click **Go To AM** and press function key **F9**.

13. Select the **Screen Saver** page of the **Interact Settings** property sheet.

Use this page to configure the screen saver. When the screen saver is enabled, AM either clears the screen or scrolls text on the display if it detects no mouse or keyboard activity for a specified number of minutes. The screen saver works only during Run Mode and helps prevent phosphor “burn” when a graphic is displayed for a long time.

AM continues to update graphics in the background while the screen saver is active. To deactivate the screen saver and re-display the screen, move the mouse, press a mouse button, or press a keyboard key.

14. Enable the screen saver by selecting the **Enabled** box.

15. Click the **Timeout Interval**, and enter **1 minute**.

16. Click the **Scrolling Text** button.

17. Click **Text**, and enter your name or any other text string you wish to use.

18. Click **OK**.

The Interact Settings property sheet closes, saving all your changes. Now you will enter Run Mode and observe your changes. In this example, do not activate the PTM tools. You will investigate all the features of the PTM example in the next chapter.

19. On the **Run** menu, click **Run Interact**.

20. Click on **Yes** in the **Save** dialog box.

You enter the Interact Run Mode, and the PTM panel appears. The panel is displayed in colors that would be appropriate for a Plasma display. Changing the Display Type parameter from Color to Plasma caused this effect.

21. Press the **F9** function key.

The Application Manager Run Mode menu is displayed. Do not use the keyboard or move the mouse for one minute.

The Screen Saver activates and scrolls the text you entered across the display. Now you will

- return to the Interact development environment.
22. Move the mouse.
The Application Manager Main Menu displays.
 23. Click **Exit Interact**; then, click **Accept**.
You are returned to the Interact development environment.
 24. On the **File** menu, click **Interact Settings**.
 25. Select the **Run Mode Display** page of the **Interact Settings** property sheet.
 26. Click the **Display Type** box, and select **Color** for the display type.
This returns the display back to Color the next time you enter Run Mode.
 27. Select the **Keys** page of the **Interact Settings** property sheet.
 28. Click **Go To AM** and press function key **F10**.
This returns the Go To AM selection key back to F10.
 29. Select the **Screen Saver** page of the **Interact Settings** property sheet.
 30. Disable the screen saver by clearing the **Enabled** box.
 31. Click **OK**.
All parameters are back to their original states.

Configuring Application Settings

In this section you will make changes to the Application Settings property sheet. Changes made to the Application Settings property sheet only affect the currently loaded application. For detailed information on each parameter, see the Application Manager help file.

You will select the PTM example application shipped with the PTM module, change several application settings, and observe the changes in Run Mode. If you do not have PTM, just read through the steps below.

Important You must remember to change the application settings back to their previous state; otherwise, when you run the PTM example in the next chapter, it will not work properly.

To change Application Settings, follow these steps:

1. On the **File** menu, click **Open Application**.

A list of available projects appears.

2. Double-click the **APPFILES** folder.

The APPFILES folder opens.

3. Click **Example**.

4. Click **OK**.

The Application Browser appears with Example application loaded.

5. On the **Run** menu, click **Run Interact**.

6. Click **Yes** to the **Save** dialog box.

You enter the Interact Run Mode. The PTM panel appears as shown in the previous section on Configuring Interact Settings.

Notice that when Interact started in the runtime environment, Run Mode was the startup mode, and the PTM module was the startup module. Now you will make Program Mode the startup mode.

7. Click the **Go To AM** button on the PTM panel.

The Application Manager Run Mode menu appears.

8. Click **Exit Interact**; then click **Accept**.

You are returned to the Interact development environment.

9. Double-click on the **Application Manager** icon in the Application Browser.

The Application Browser expands.

10. Double-click on the **Application Settings** icon in the Application Browser.

The Application Settings property sheet appears as shown below:

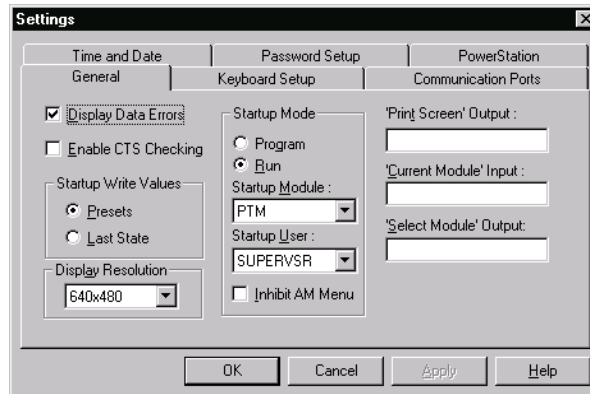

The General page is displayed once the Application Settings property sheet appears. Use this page to configure Startup Write Value, Startup Mode, and module input and output references. You can also enable CTS checking and the display of data errors.

11. Click **Program** for the Startup Mode.

This enables the application to startup in the Program Mode. Selecting this radio button disables the other parameters in this group.

12. Click **OK**.

The Application Settings property sheet closes, saving all your changes. Now you will enter Run Mode and observe your changes. In this example, do not activate the PTM tools. You will investigate all the features of the PTM example in the next chapter.

13. On the **Run** menu, click **Run Interact**.

14. Click on **Yes** in the **Save** dialog box.

You enter the Interact Run Mode. The Application Manager Main Menu appears.

Notice Interact is set to the Program Mode. The application did not enter Run Mode immediately. Changing the Startup Mode parameter from Run to Program caused this effect.

15. Click **Exit Interact**; then click **Accept**.

You are returned to the Interact development environment.

16. Double-click on **Application Settings** in the Application Browser.

17. Click on the **Run** button on the General page.

This returns the Startup Mode back to Run Mode.

18. Click **OK**.

All parameters are back to their original states.

Experiment!

This chapter provided only a brief introduction to the features of AM. The best way to learn is to experiment.

- Read and work through the other examples provided in this manual.
- Create a new application with only the PTM module and the Demo driver.
- Build a simple tool and change various Interact and application settings, and see the effect on application operation.

Panel Toolkit Module

The Panel Toolkit Module (PTM) is an Interact software module that runs under the control of the Application Manager (AM). PTM includes over 30 pre-configured panel tools, which replace traditional hardware, creating a more direct and powerful link between operator and machine. This chapter provides an overview of PTM and includes an example that shows you how to build panels of tools.

Chapter Contents

<i>Overview of PTM</i>	43
<i>Overview of the Example Application</i>	44
<i>Using the Demo Device Driver</i>	44
<i>Running the Example Application</i>	45
<i>Using PTM Tools</i>	46
<i>Understanding User Levels</i>	63
<i>Adding a Panel to the Example Application</i>	67
<i>Testing the Example Application</i>	73
<i>Experiment!</i>	74

Overview of PTM

PTM allows you to quickly and easily construct an operator interface panel consisting of input tools and output tools. These tools are graphical objects modeled after real input/output devices such as push buttons, meters, numeric displays, bar graphs, etc. You can place the tools on the panel and attach them to discrete or analog variables in your controller.

For increased capability, PTM is designed to work hand-in-hand with the Graphics Monitoring Module (GMM). GMM is another Interact software module that runs under control of the Application Manager and always accompanies PTM. GMM allows you to create graphic objects using simple graphic units such as lines, boxes, circles, polygons, arcs, and text. You can connect these objects to variables in your controller, allowing you to create panels that contain animated processes or machine diagrams along with PTM tools.

The term “panel” is used to describe a single screen containing an assortment of graphical objects, representing input and output devices called “tools.” Typically, an operator uses several, if not many, panels to monitor and control a machine or process.

In the development environment, you can design and configure your panels. In the runtime environment, panels are viewed by the operator, and the tools on them are connected to the discrete and analog variables in the controller. The operator may select which panels to view.

Overview of the Example Application

This section provides hands-on experience using the Panel Toolkit Module (PTM). The example application, Example, consists of a pre-configured panel. The following features are demonstrated in the example application:

- Running the Application Manager and loading the application
- Using the pre-configured PTM tools in Run Mode
- Adding PTM tools in the development environment
- Testing the modified example

Using the Demo Device Driver

The demo device driver is provided for you to use with the example application. The example application does not require you to interface with a controller. However, you can assign addresses to tools using the demo device driver, just like you would when using a standard device driver. Input data is passed to the output address by the demo driver as shown below:

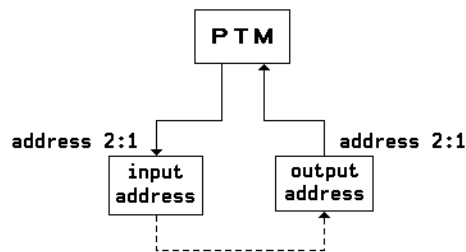

In the figure above the input and output address are the same; input data appears at the output address. Therefore, the driver loops back input data.

The demo driver address format is shown below:

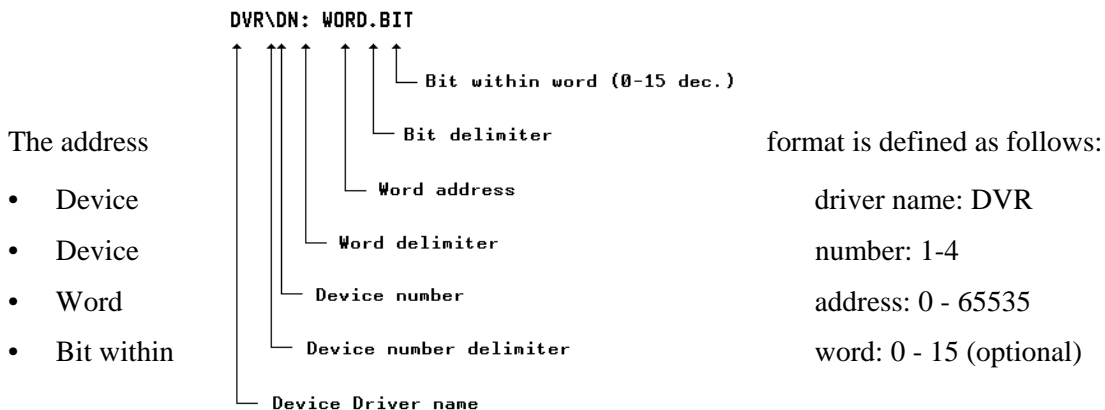

For example, you could enter DVR\1:3. The address format for this example appears below:

- Device driver name: DVR
- Device number: 1
- Word address: 3

Or you could enter DVR\3:234.7. The address format for this example appears below:

- Device driver name: DVR
- Device number: 3
- Word address: 234
- Bit within word: 7

Running the Example Application

To access the example application you must first run the Application Manager.

To run the example, follow these steps:

1. Launch Interact from the MachineShop toolbar.
2. On the **File** menu, click **Open Application**.

A list of available projects appears.

3. Double-click the **APPFILES** folder.

The APPFILES folder opens.

4. Click **Example**; then click **OK**.

The Application Browser appears with the Example application loaded.

5. On the **Run** menu, click **Run Interact**.
6. Click **Yes** when you are asked to save changes.

You enter the Interact Run Mode. The first PTM panel, titled “Tools,” appears as shown below:

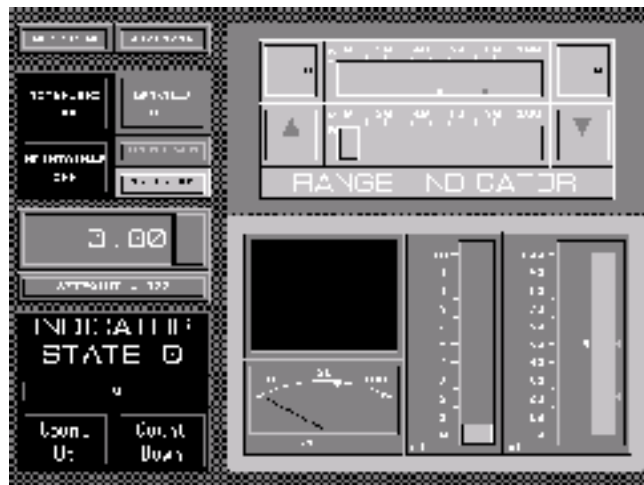

PTM provides you with a wide variety of tools for use in your application. The example application uses two panels with sample input and output tools to demonstrate how these tools work. Panel #2 is titled “Trend.” The panel designer assigns panel names when he creates his application.

To view Panel #2, click the aqua “Trend Scn” button. When you want to toggle back to the first panel, click the gray “Go to Previous Panel.”

Using PTM Tools

This section groups the tools on each panel for descriptive purposes. Each of the following sections provides a general tool description and an explanation on how each tool is used in this example during Run Mode. You should read each tool group’s description prior to manipulating the device. For details on tool configuration parameters, refer to the Panel Toolkit Module online help file.

Time and Date Tools

The Time Display and Date Display tools allow you to display the current time and date on any panel. These tools are shown below as they appear on Panel #1:



Push Button Tools

Push Button tools work much the same as ordinary lighted push buttons. You can use them to control a discrete input bit whenever they are pressed and released. You can also use them to reflect the status of a discrete output bit by changing their text and/or color according to the output bit state.

You must assign a discrete input address to a Push Button. This is the bit which will be controlled by the button. An optional output address may be used to allow the button to monitor the status of a bit (i.e. change the color and/or text of the button when the bit goes high). The following is a list of the three types of Push Buttons:

- Momentary Push Buttons
- Maintained Push Button
- Latched Push Buttons

These tools are shown below as they appear on Panel 1:



Momentary Push Button

A Momentary Push Button sets a discrete input bit in your controller with the press of a button. You may also assign a discrete output bit to control the appearance of the tool lens.

A Momentary Push Button retains its state only while the button is being pressed. This means the discrete input bit changes state when it is pressed and returns to its previous state when the user releases the button.

To use the Momentary Push Button, complete this step:

- Click the **Momentary Push Button**.

Notice that the button lens color and text change. This is because the output bit address is the same as the input bit address. The Push Button lens reflects the output bit state.

Maintained Push Button

A Maintained Push Button sets a discrete input bit in your controller with the press of a button. A Maintained Push Button retains its state when it is pressed and released. This allows the Maintained Push Button to act as toggle switch because releasing the button does not affect the input bit.

To use the Maintained Push Button, follow these steps:

1. Click the **Maintained Push Button**.

Notice that the button remains On once you release it.

2. Click the **Maintained Push Button** again, and notice that the button returns to the Off state.

We assigned the function key F2 to this Push Button.

3. Press **F2** to move the cursor over the **Maintained Push Button** and actuate the device.
4. Press **F2** again to release the **Maintained Push Button**.

Latched Push Button

You control the state of a Latched Push Button with the state of the unlatch output bit as well as the input bit. Once you press the Latched Push Button, the controller's logic program monitors the unlatch output bit. When the output bit is triggered, Interact knows to reset the input bit. This pushes the Latched Push Button back out.

This type of button is useful if your controller has an unusually long scan time that may cause it to miss button presses. An additional use for this Push Button would be to synchronize button presses with events in the controller's logic program.

For the purposes of this example, the Momentary Push Button input address is assigned as the unlatch output bit address. Thus, pressing the Momentary Push Button releases the Latched Push

Button from its On state.

To use the Latched Push Button, follow these steps:

1. Click the **Latched Push Button**.
2. Click the **Momentary Push Button**.

Observe the results on the Latched Push Button.

Analog Input and Output Tools

An analog tool is used to monitor or control an analog value in the controller. You must enter an address reference to the desired value (word or register) in the controller.

The Input address reference assigns the address of the analog value to be controlled by the tool. The Analog Output address reference assigns the address of the analog value to be monitored and displayed by the tool. This area of the display is composed of both analog input and analog output tools.

These tools are shown below as they appear on Panel #1:

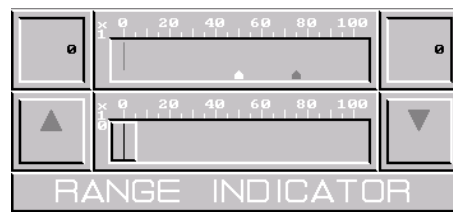

In this group of tools, the three input tools are configured to control the data at the same address, and the three output tools are configured to monitor the same data values. Thus, output tools update to display the data entered in the input tools.

To use the Analog Input and Output Tools, follow these steps:

1. Click on the **Slide** tool control (gray tab).
2. Drag the **Slide** tool control, and observe the output tools.
3. Click on the **Increment** and **Decrement Buttons**, and observe the output tools.

Input Tools

Analog Input tools allow you to control data at an analog input address. The above portion of the example panel includes the following analog input tools:

- Slide

- Increment Button
- Decrement Button

Slide

Slide tools allow you to enter data values to be written to an analog address. Moving the Slide control enters data from the tool's selected range into the input address. This range is user defined.

In this example the Slide tool ranges from 0 to 1000. The data from this tool is used to control the data displayed on the Numeric Display tool and the Bar Graph. Also, the message displayed on the Range Indicator is dependent upon the Slide tool data.

To use the Slide tool, complete this step:

- Click the **Slide** tool control (gray tab), drag it, and observe the data on the **Numeric Display** and the **Bar Graph**. The **Range Display** message also changes based on the numeric setting.

Notice that if you use the Increment or Decrement Buttons to change the data value, clicking on the Slide tool also adjusts the Slide to the new value. In this application, the Slide tool acts as the coarse adjustment, while the Increment and Decrement Buttons act as the fine adjustment.

Increment Button

Increment Buttons increase a data value located at an analog input address. Pressing the button increases the data value at the analog input address by an amount configured by the designer for that tool.

In this application, the Increment Button controls the value displayed on the Numeric Display and the Bar Graph tools. The data value is set to increment by 1 each time the button is pressed, and the maximum value is set to 1000. You cannot exceed this value.

The font selected for both the pressed and released lens state is the symbols1 font. With the symbols1 font, you may assign graphical icons to the lens. Refer to the Application Manager online help for all font tables.

To use the Increment Button, complete this step:

- Click on the **Increment Button**, and observe the **Numeric Display** and **Bar Graph** tools.

Decrement Button

Decrement Buttons decrease a data value located at the tool's input address. Pressing the button decreases the data value by the amount configured for the tool.

In this application, the Decrement Button controls the value displayed on the Numeric Display and the Bar Graph tools. The data value is set to decrement by 1 each time the tool is pressed, and the minimum value is set to 0. You cannot go below this value.

The font selected for both the pressed and released lens states is the symbols1 font. With the symbols1 font, you may assign graphical icons to the lens. Refer to the Application Manager online help for the symbols1 font table.

To use the Decrement Button, complete this step:

- Click on the **Decrement Button**, and observe the **Numeric Display** and **Bar Graph** tools.

Output Tools

Analog Output tools allow you to monitor data at an analog output address. The example panel includes the following analog output tools:

- Bar Graph
- Numeric Display
- Range Indicator

Bar Graph

A Bar Graph monitors and displays data from an analog output address. The Bar Graph tool is designed to display analog values, but discrete values can also be displayed.

The minimum and maximum values assigned to the Bar Graph is 0 to 100, while the values assigned to the Slide tool are 0 to 1000. The address assignment for the Bar Graph has been configured to scale the data it receives from the output address by dividing it by 10. Thus, the value controlled by the Slide tool is divided by a factor of 10 prior to display by the Bar Graph.

Notice the small triangular markers on the Bar Graph. These markers indicate where limits are assigned. (The limits are 50 and 75 which represent an input data value of 500 and 750 prior to scaling). As the Bar Graph moves through the limits, the bar color changes.

Numeric Display

Numeric Displays monitor and display data from output addresses. You can assign minimum and maximum values to this tool that define the low and high range of that particular tool.

This tool reads the data value controlled by the Slide or Increment and Decrement tools. Any change in these tools appears on the display.

In this example, the field size has been set to 4 with no decimal places. The minimum value is set to 0, and the maximum value is 1000. Limits are set to 500 and 750.

Range Indicator

The Range Indicator displays message text based on data monitored from an analog output address. This tool can be used to display cautions and warnings to the user indicating when a condition requires attention.

In this example, as the Slide or Increment/Decrement Buttons are actuated, the Range Indicator changes the displayed message. The limits where the message and lens change are at 500 to 750.

To observe the bar graph, numeric display, and range indicator, follow these steps:

1. Click the **Slide** tool control (gray tab), drag it, and observe the **Bar Graph**.

The bar color changes when the slider moves past 500 and changes again when the slider moves past 750.

2. Click the **Increment** and **Decrement** tools, and observe the **Range Indicator**.

The Range Indicator changes the message and color when either the Slide tool or the Increment and Decrement buttons move the value past 500 and 750.

Meter and Message Display Tools

This area of the display is composed of both input and output tools. These tools are shown below as they appear on Panel #1:

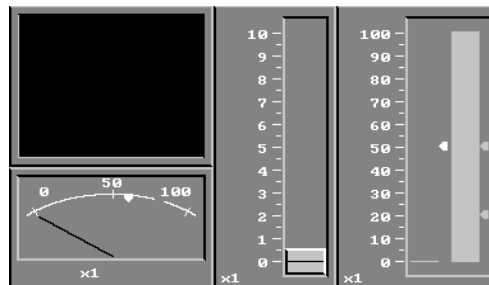

In this group of tools, the data controlled by the Slide tool is monitored by the output tools. Hold down on the gray slide tab, and move it, while observing the effect on the output tools.

Input Tools

Analog Input tools allow you to control data at an analog input address. The example panel includes the following analog input tool.

Slide

Slide tools allow you to enter data values into an analog input address. This tool is similar to the Slide tool described earlier. Moving the slide enters data within the tool's range into the input address.

In this example, the Slide tool ranges from 0 to 10. Both the Meter and Bar Graphs scale this data prior to displaying it. The Local Message Display tool displays messages based on the data value read from the Slide tool.

To use the Slide tool, complete this step:

- Click the **Slide** tool control (gray tab), drag it, and observe the output tools.

Output Tools

Analog Output tools allow you to monitor data at an analog output address. The example panel includes the following analog output tools:

- Bar Graph
- Meter
- Local Message Display

Bar Graph

This Bar Graph is similar to the Bar Graph previously described. A Bar Graph monitors and displays data from an analog output address. The Bar Graph is designed to display analog values, but discrete values can also be displayed.

As you move the Slide tool control, the Bar Graph monitors the data value. In this example the bars complement each other so that when one bar is at the minimum value, the other is at the maximum value.

In this example, the Bar Graph ranges from 0 to 100. Since the range of data from the Slide tool is 0 to 10, scaling is performed on the data value read from the Slide tool. For the bar on the left, the data value is multiplied by 10 prior to display. For the bar on the right, the data value is multiplied by 10 and subtracted from 100 prior to display.

Notice the markers on the Bar Graph. These markers indicate where each limit is assigned. There are limits assigned to each bar so that when a limit is passed, the bar color changes. For the left bar, the limits are 50 and 80. For the right bar, the limits are 50 and 20.

Meter

A Meter monitors and displays data from an analog address. The position of the meter's needle reflects the data read from the output address.

As you move the Slide tool control, notice that the Meter needle moves to reflect the monitored data value. When the needle passes its limits the needle changes color. The limits are currently set to 60 and 80. Data controlled by the Slide tool is multiplied by 10 before it is displayed on the Meter.

Local Message Display

The Local Message Display displays local messages that you create and store in PTM. The controller's logic program controls which message is displayed by placing a message number in a register. Each message has a number associated with it. The Local Message Display tool monitors this register and determines if a message has been created that matches this register value. If a message exists, it is displayed; otherwise, no message is displayed.

In this example there are 10 separate messages which combine to form a single sentence. Each message is assigned a message number. When the data value read from the Slide tool matches a message number, that particular message is displayed.

To observe the Bar Graph, Meter, and Local Message Display tools, follow these steps:

- Click the **Slide** tool control (gray tab), drag it up and down.

As the Slider passes 50 and 80, the left Bar Graph changes color. As the Slider passes 20 and 50, the right Bar Graph changes color.

The Meter needle changes colors as the Slider moves past 60 and 80.

As the Slide tool passes a whole number (1, 2, 3, etc.), a different message is displayed.

Numeric Entry and Set Button Tools

This area of the display is composed of input tools. With this set of tools, we assigned both tools to the same analog address. These tools appear on Panel #1 as shown below:



Numeric Entry

The Numeric Entry tool allows you to enter data through a keypad device into an analog address. The keypad device is either an internal keypad (appears on your computer screen) or an external keypad (the numeric keypad on your computer's keyboard). Access the keypad device by clicking on the Numeric Entry tool.

To use the internal keypad, click on the screen's keys for each number. Use the enter key to enter a data value into the analog input address. Click on the Cancel key to return to the display and abort any data entry.

To use the external keypad, enter your data value using the keys on your keypad. Press Enter to enter data, and press the Esc key to abort the data entry.

An internal keypad appears below:

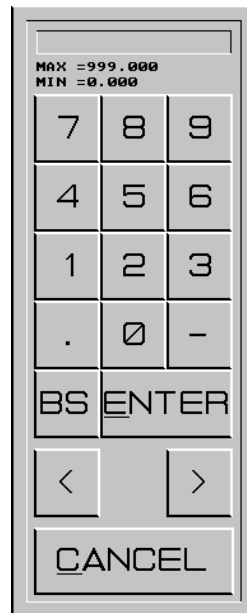

To use the Numeric Entry tool, follow these steps:

1. Click the **Numeric Entry** tool.
2. When the keypad pops up, enter data by clicking the numeric keys.
3. When you finish entering data, click the **Enter** key of the keypad to close the internal keypad and display the data on the Numeric Entry tool.

The keypad has two arrow keys that allow you to move the keypad from one side of the display to the other. You can assign the default position for a keypad when you configure the tool. Function key F4 is assigned to the Numeric Entry tool, so pressing F4 pops up the keypad and allows data entry.

Set Button

The Set Button tool writes a predefined value to the assigned analog input address each time you press the button. You can assign this predefined value when configuring the tool.

To use the Set Button, complete this step:

- Press the **Set Button**.

When you press the Set Button, a value of 500 is sent to the Numeric Entry tool. The address where the value is written is the same address monitored by the Numeric Entry tool.

Function key F5 is assigned to the Set Button tool. Press F5 to move the cursor to the tool and actuate the tool.

Increment Buttons and Indicator

This area of the display is composed of both input and output tools. These tools appear on Panel #1:

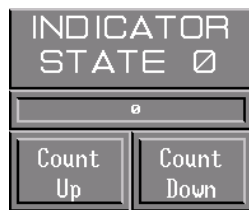

Input Tools

Analog Input tools allow you to control data at an analog input address. The above portion of the example panel includes the following analog input tools:

- Increment Button
- Decrement Button

Increment Button

Increment Buttons increase a data value located at an analog input address. Pressing the button increases the data value by the amount configured for the tool.

In this application, the Increment Button controls the value displayed on the Numeric Display and the Indicator tools. The data value is set to increment by 1, and the maximum value is set to 100. You cannot exceed this value.

The font selected for both the pressed and released lens state is the system2 font. Refer to the Application Manager online help for all font tables.

To use the Increment Button, complete this step:

- Click the **Increment Button**, and observe the **Numeric Display** and **Indicator** tools.

Notice the Numeric Display counts from 0 to 7, depending on the current state. Also, the Indicator message and background color change to reflect the current state.

Decrement Button

Decrement Buttons decrease a data value located at an analog input address. Pressing the button decreases the data value by the amount configured for the tool.

In this application, the Decrement Button controls the value displayed on the Numeric Display and the Indicator tools. The data value is set to decrement by 1, and the minimum value is 0. You cannot go below this value.

The font selected for both the pressed and released lens state is the system2 font. Refer to the Application Manager online help for all font tables.

To use the Decrement Button, complete this step:

- Click the **Decrement Button**, and observe the **Numeric Display** and **Indicator** tools.

Notice the Numeric Display counts from 0 to 7, depending on the current state. Also, the Indicator message and background color change to reflect the current state.

Output tools

Analog Output tools allow you to monitor data at an analog output address. The above portion of the example panel includes the following analog output tools:

- Numeric Display
- Indicator

Numeric Display

Numeric Displays monitor and display data from an analog address in the controller. You can assign minimum and maximum values to this tool that define the low and high range of the

tool. These values are also used during tool limit assignments.

This tool reads the data value controlled by the Increment and Decrement Buttons. Any change in these tools appears on the display. In this example, the field size has been set to 1 with no decimal places. The minimum value is set to 0, while the maximum value is set to 100.

Indicator

The Indicator monitors up to three discrete outputs. These can control up to a maximum of eight states (lens colors and text messages) on the Indicator. As the outputs change, the Indicator also changes state.

The table below lists each discrete output combination and the corresponding Indicator state.

Discrete Output 0	Discrete Output 1	Discrete Output 2	Indicator State Displayed
0	0	0	State 0
1	0	0	State 1
0	1	0	State 2
1	1	0	State 3
0	0	1	State 4
1	0	1	State 5
0	1	1	State 6
1	1	1	State 7

To observe the Numeric Display and Indicator tools, follow these steps:

1. Click on the **Count Up** or **Count Down Increment** and **Decrement** buttons located below the **Indicator**.

Notice that each time you press one of these buttons, a different state is displayed by the Indicator. Once you reach the maximum (7), the Increment button cannot increase the Indicator state. Likewise, once you reach the minimum state (0), the Decrement button cannot decrease the Indicator state.

2. Now observe the **Numeric Display** as you click the **Increment** and **Decrement** buttons.

Action Tools

This area of the display is composed of the following tools. These tools are shown below as they appear on Panel #1:



Action Tools allow access to functions local to the Interact software. When you press an Action Tool, a specific function is performed. Panel #1 includes the following Action Tools:

Next Panel (Trend Scn)

Go to AM

Next Panel and Go to AM

The Next Panel tool loads the next panel in the PTM Runtime Panel List. The Runtime Panel List is a list of panels to be used during Run Mode. This list is considered to be a continuous loop. This means if the last panel in the list is currently loaded, pressing the Next Panel button loads the first panel in the list.

The Go to AM button brings the Application Manager screen into the foreground.

In this example we have created two separate PTM panels. Panel #1 of this example is called the Tools panel (the current panel loaded in this example). Panel #2 is called the Line Trend panel. We are using a Next Panel Action Tool to access the Line Trend panel.

You can use another Action Tool, Go to AM, to return to the Application Manager Main Menu.

To use an Action Tool, complete this step:

- Click on the **Trend Screen Action** button.

The Line Trend panel, Panel #2, appears as shown below:

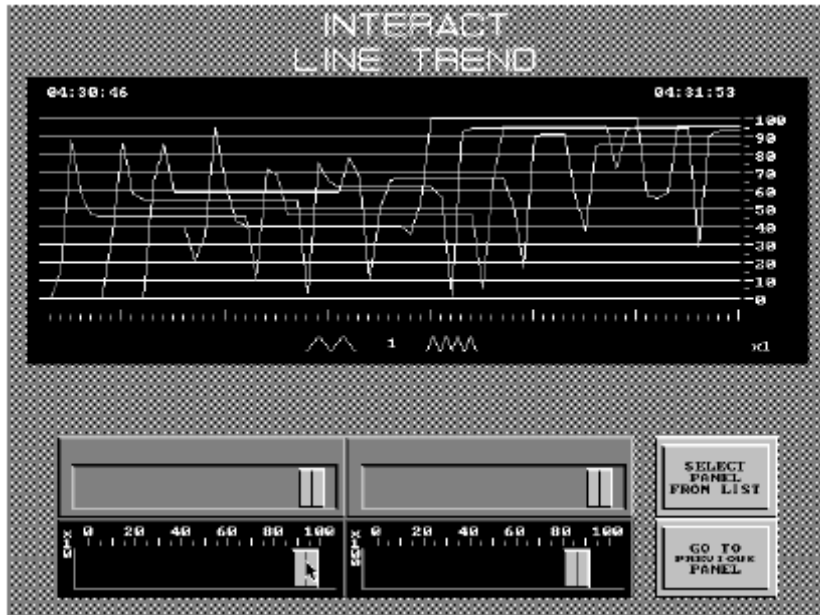

Now practice with the remaining tools used by this example.

Line Trend

This area of the display is composed of both input and output tools. In this set of tools the analog input addresses assigned to the Slide tools are monitored by the Line Trend. These tools are shown below:

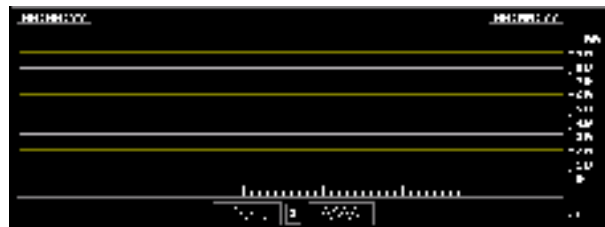

Input Tool

Analog Input tools allow you to control data at an analog input address. The example panel includes four analog input slide tools.

Slide

There are four data values monitored by the Line Trend. Each Slide controls a separate line. Notice that each Slide tool has different minimum and maximum values assigned. The Line Trend has a minimum and maximum range of 0 to 100 assigned.

Data for each of the four trends are derived from four separate address assignments:

- Line trend 1 (green) monitors the data from the upper left Slide tool (green) and multiplies the data by a factor of 10 prior to display.
- Line trend 2 (cyan) monitors the data from the upper right Slide tool (cyan) and displays the data directly.
- Line trend 3 (red) monitors the data value from the lower left Slide tool (red) and divides the data by a factor of 10 prior to display.
- Line trend 4 (magenta) monitors the data value from the lower right Slide tool (magenta) and divides the data by a factor of 100 prior to display.

To use the Slide tool, complete this step:

- Click the **Slide** tool control (gray tab), drag it, and observe the **Line Trend** display.

Output Tool

Analog Output tools allow you to monitor data at an analog output address. The example panel includes the analog output Line Trend tool.

Line Trend

A Line Trend tool provides trend analysis by representing data values as lines on a graph. Data from four separate analog output addresses may be graphed.

There are two selection keys on the bottom of the Line Trend tool. These keys are expand level keys which control the expansion level of the line trend. In other words, they zoom in and out on the line trend tool so you can either see more detail or get a broad picture of total activity. Expanding the line trend allows you to view the graphed data in greater detail. The left key increases the expansion level, while the right key decreases the expansion level.

As the expansion level changes, the number inside the expansion window also changes. There are a maximum of five levels available with level five representing the highest possible expansion of the line trend. Level one represents normal viewing. The size of the tool determines how many expansion levels there are for the particular tool. The larger the tool, the more expansion levels are available.

To observe the Line Trend, complete this step:

1. Click each of the **Slide** tool controls (gray tab) on this panel, and observe the **Line Trend**.

Notice that by assigning different colors to the Line Trend it is easier to spot a change in a particular data value. In this example, there are a maximum of 68 events that can be graphed.

2. Click the **expand level** keys, and observe the results.

As you increase or decrease the expand level, the line graphs expand or contract according to the level you select.

Action Tools

Action Tools allow you to access functions local to the Interact software. When you press an Action Tool, the specific function is performed. The example panel (Trend Panel) includes the following Action Tools:

- Load Panel
- Previous Panel

These tools are shown below as they appear on Panel #2:



Load Panel and Previous Panel

The Load Panel tool displays the PTM Runtime Panel List. You must select a panel to load from the Panel List. The Previous Panel tool loads the previous panel from the Panel List. The Panel List is considered to be a continuous loop. This means if the first panel in the list is currently loaded, pressing the Previous Panel button will load the last panel in the list.

To use the Action Tools, follow these steps:

1. Click **Go To Previous Panel** to clear Panel #2 and load Panel #1 on the display.
2. Click the **Trend Screen** Action Tool on Panel #1 to return to Panel #2.
3. Click **Select Panel from List** to pop up the Panel List.

The Panel List allows you to select a panel that you want to load. An example of the Panel List appears below:

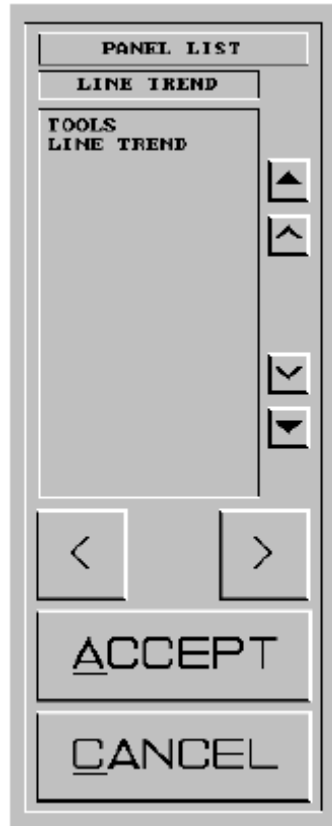

4. Click on the desired panel; then, click **Accept**.

The current panel will clear from the display, and the selected panel will load, if the panel you select is not currently loaded.

The Panel List has arrow keys along the right side that you can use to scroll through panel names. The solid arrow keys scroll the Panel List one page at a time, while the thin arrow keys scroll the Panel List one line at a time.

The arrow keys above the Accept button allow you to shift the box from side to side on the panel. You select the default position of the box when you configure the panel.

All example application tools have now been described. Return to Panel #1 of the example application by clicking on **Go to Previous Panel** button of Panel #2.

Understanding User Levels

User Levels allow you to control access to your panels. With this capability you can do the following:

- prevent individuals from accessing certain panels
- lock out access to the input tools on your panels

Each user is assigned a specific user level during configuration. That user can only access features that are assigned their level or lower.

There are six user levels available for security protection. You can assign each panel a number from 0 to 5 indicating its user level. The panel levels are defined in PTM under Settings, Panel List (Panel Level and Input Level). Level 0 provides the strictest control possible, while level 5 allows unrestricted access to all panel functions and features. The example application has the following user levels assigned to each panel:

	User Level to View the Panel	User Level to Input on the Panel
Panel #1	5	3
Panel #2	4	3

Thus, anyone assigned user level 5 or lower can view Panel #1, but only individuals with user level 3 or lower can actually input data. Individuals with user level 5 will not be able to view Panel #2 since the panel is assigned user level 4. In this application you must return to the AM Main Menu to change the current user level.

To change user levels, follow these steps:

1. Ensure **Panel #1** is displayed on the screen.
2. Click on **Go To AM** Action Tool.
2. The Application Manager Run Mode screen is displayed as shown below:

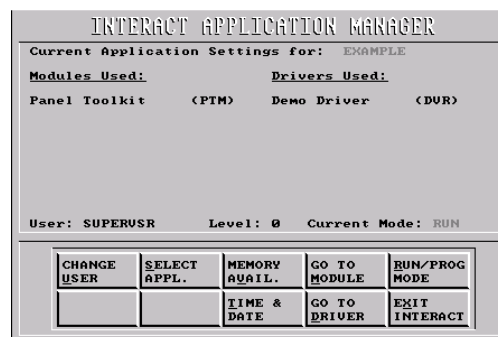

3. Click on **Change User**.

This allow you to change the existing user. The cursor moves to the Password prompt. Each user name has a password assigned that must be entered prior to accessing the desired panel. Passwords may be up to fifteen characters (alphanumeric) in length.

In this example, the passwords were chosen to match the user level for clarity only. In an actual application you probably would want to assign a password that is not so obvious.

4. Type **5555**; then press **Enter**.

You are now at user level 5. Notice that the Application Manager Main Menu has fewer selection keys available. The higher the user level, the fewer available functions there are. Now return to PTM with this new user level.

5. Click on **Go To Module**.

Notice that security protection symbols are placed over the tools that you can not access. With this user level you can not access any input tools. You are only able to view the panel. Remember this is the highest restricted level.

The password restricted panel is shown below:

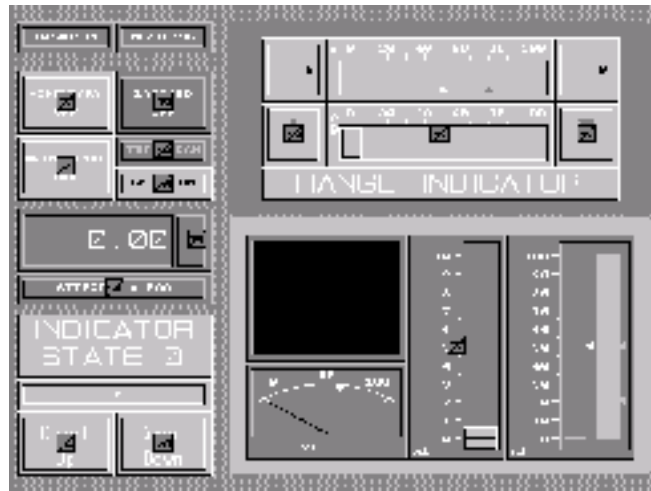

6. Press function key **F10** to return to the Application Manager Run Mode screen.
7. Click on **Change User**.
8. Type **0**; then, press **Enter**.

You are now at user level zero again.

9. Click on **Go To Module**.

Now you have unrestricted access to all tools on the panel.

10. Press function key **F10** to return to the Application Manager Run Mode screen.
11. Click **Exit Interact**; then, click **Accept**.

You are returned to the Interact development environment.

Adding a Panel to the Example Application

In this part of the example, you will enter the development environment and add tools to a panel. These tools are configured so you can understand how a panel is created.

Creating a New Panel

To create a new panel, follow these steps:

1. Double-click on the **Panel Toolkit Module (PTM)** icon in the Application Browser window.
2. Double-click on the **Panels** icon.
3. Double-click on the **New** icon.

A blank PTM panel appears.

4. Click on the **Maximize** button to maximize your viewing window.
5. On the **Edit** menu, click **Background**; then, click **Color/Pattern**.

The Background Pattern Selection dialog box appears as shown below:

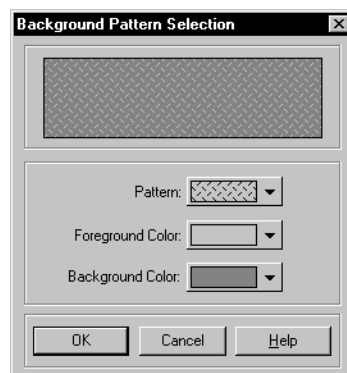

This allows you to assign foreground and background colors to your panel. You are doing this as the first step in creating a new panel; however, the background may be changed at any time during development.

























Each panel has a background on which the tools are placed. The pattern and color of the background can be changed through the Background Pattern Selection dialog box.

6. Experiment with selecting various display patterns and background and foreground colors by clicking on boxes within the **Background Pattern Selection** dialog box.

7. Once you decide on a pattern and color for the background, click **OK**.

Using the PTM Toolbar

When you wish to add tools to your panel, you must find the tool on the Toolbox found on the right side of the PTM window. Below we have identified for you each tool available on the Toolbox.

	Push Button		Increment/Decrement Button
	Set Button		Action Button
	Numeric Entry		Selection Entry
	Slide		Input List
	Input Area		Indicator
	Range Indicator		Numeric Display
	Meter		Counter
	Bar Graph		Line Trend
	XY Plot		PID Faceplate
	Local Message Display		Remote Message Display
	Message Entry Display		Remote List Display
	Time Display		Date Display
	Panel Label		

Adding Tools to the Panel

In this example, you will make the following three tools:

- Slide
- Bar Graph
- Action Tool (Previous Panel)

You will configure the Slide tool to write data to an analog input address that will be monitored by the Bar Graph tool. Thus, the Bar Graph will update when the gray control tab on the Slide is moved.

The Previous Panel Action Tool will be configured to return you to the Line Trend panel of the example application.

Select tools by clicking on the appropriate tool icon in the Toolbox on the right side of the screen, or click New, then Tool, from the Object Menu. Then drag within your panel to create the tool.

Note When you place the cursor over different tool icons on the Toolbox, notice that the tool name appears over each icon.

To add the Slide tool, follow these steps:

1. Click on the **Slide** icon in the Toolbox.
2. Position the cursor on the screen where you want the tool to appear.
3. Hold down the left mouse button, and drag the mouse until an outline of a **Slide** tool appears.

Note The Slide tool can only be configured for two sizes.

4. Release the mouse button, and the Slide tool appears.
5. Double-click on the **Slide** tool to configure it.

The Slide property sheet appears as shown below:

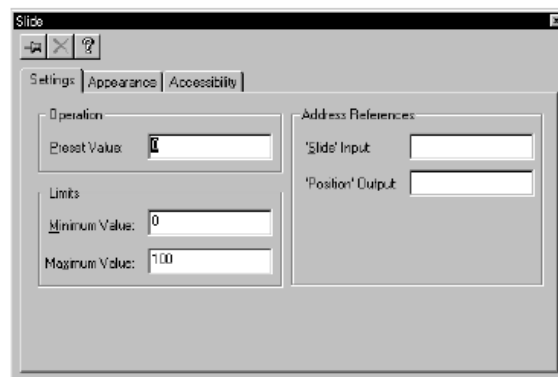

6. Leave the parameter in the enter a value
7. Click in the display the Address Reference dialog box.

Minimum Value assigned a value of **0**. **Maximum Value** box, of **1000**.

Slide Input box to

The Address Reference dialog box appears as shown below:

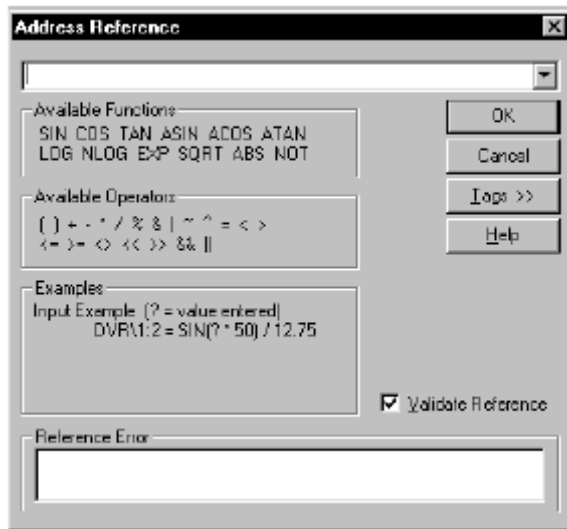

8. Enter the address reference string by typing **DVR\ 1:1**.
9. Click **OK** to accept the address and return to the Settings page.
10. Click the **Appearance** page of the Slide property sheet.
11. Select a color by clicking the **Tool Color** box.

Choose a color from the color well.

12. Click off the property sheet to close it.

The Slide tool is now configured.

To add the Bar Graph tool, follow these steps:

1. Click on the **Bar Graph** icon in the Toolbox.
2. Position the cursor on the screen where you want the tool to appear.
3. Hold down the left mouse button, and drag the mouse until an outline of a **Bar Graph** appears.
4. Release the mouse button, and the **Bar Graph** tool appears.
5. Double-click on the **Bar Graph** tool to configure it.

The Bar Graph property sheet appears as shown below:

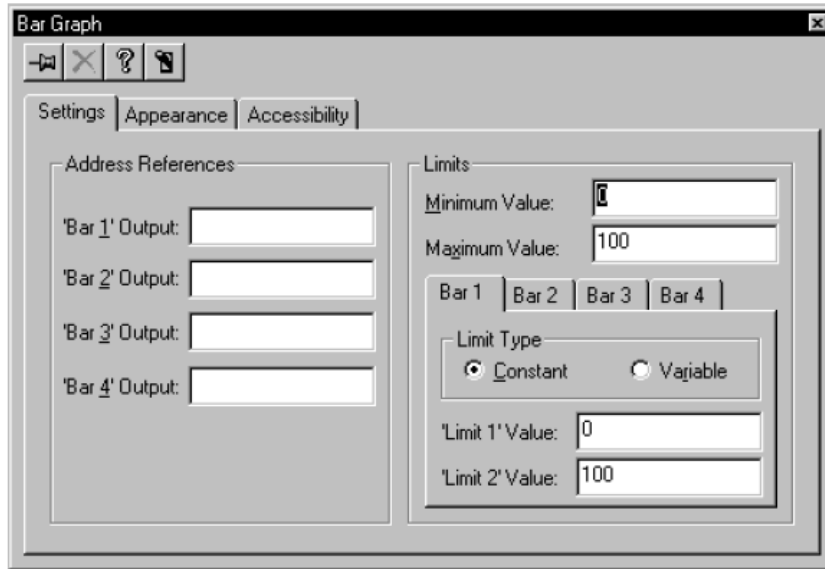

6. Leave the **Minimum Value** parameter assigned a value of **0**. In the **Maximum Value** box, enter a value of **1000**.
7. Click in the **Bar 1 Output** box to display the Address Reference dialog box.
8. Enter the address reference string by typing **DVR\ 1:1**.

Note You can also press the Up arrow key on the keyboard to automatically enter the last-entered address reference.

9. Click **OK** to accept the address and return to the Settings page.
10. Click the **Appearance** page of the Bar Graph property sheet.
11. Select a color by clicking the **Tool Color** box.

Choose a color from the color well.

12. Click off the property sheet to close it.

The Bar Graph tool is now configured.

To add the Previous Panel Action Tool, follow these steps:

1. Click on the **Action Button** icon in the Toolbox.
2. Position the cursor on the screen where you want the tool to appear.
3. Hold the left mouse button, and drag the mouse until an outline of a button appears.

4. Release the mouse button, and the Action Tool appears.
5. Double-click on the **Action Button** tool to configure it.

The Action Button property sheet appears as shown below:

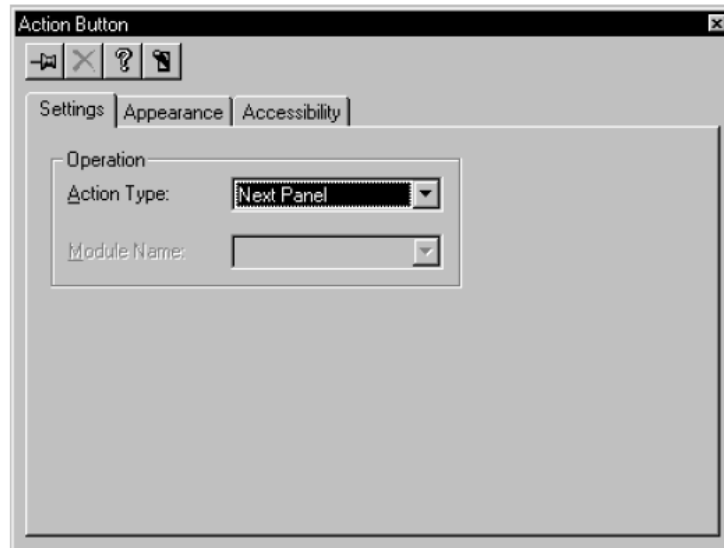

6. Click **Previous Panel** in the Action Type box.
 7. Click the **Appearance** page of the Action Button property sheet.
 8. Select a color by clicking the **Tool Color** box.
- Choose a color from the color well.
9. Click off the property sheet to close it.

The Action Tool is now configured.

Saving the Panel and Adding it to the Panel List

To save your panel, follow these steps:

1. On the **File** menu, click **Save Panel**.

The Save As dialog box appears. Notice the Add to Runtime Panel List box is selected.

2. Click **Save**.
3. Close the panel.

Testing the Example Application

Once you have saved the panel and added it to the Panel List, you are ready to test the modified example application.

Returning to Run Mode

To return to Run Mode, follow these steps:

1. From the **Application Browser**, click the **Application Manager** icon.
2. On the **Run** menu, click **Run Interact**.
3. Click **Yes** when you are asked to save changes.

To view the panel changes in Run Mode, follow these steps:

1. Click on the **Trend Screen** Action Tool.

The Line Trend panel (Panel #2) appears.

2. Click on the **Select Panel From List** Action Tool.

The Panel List selection box pops up on the right of the display. Your newly created panel will be displayed in this list.

3. Click on **Panel 1** (the panel you created); then, click **Accept**.

The Line Trend panel clears, and your panel loads into memory.

4. Experiment with moving the **Slide** tool control while observing the **Bar Graph**.

5. Click on the **Previous Panel** Action Tool to clear your panel and load the Line Trend panel.

This occurs because the Line Trend panel is listed as the number two panel on the Runtime Panel List.

6. Click on **Go to Previous Panel**.

7. Click on **Go to AM**.

The Application Manager Main Menu appears.

8. Click on **Exit Interact**; then, click **Accept**.

You are returned to the Interact development environment.

Experiment!

This chapter provided only a brief introduction to the features of PTM. The best way to learn is to experiment.

- Go to the development environment, and load one of the example PTM panels. Look at each tool's configuration property sheet and how each parameter was assigned. Compare this to the performance you observed in Run Mode.
- Create a panel, and place a PID tool on the panel. Practice configuring the PID tool and observing its characteristics.
- Use the Action List to assign function keys to various actions. The keys assigned on this list take precedence over function keys assigned to tools.

Graphics Monitoring Module

The Graphics Monitoring Module (GMM) is used to produce free-form graphics and animation using a CAD-like, object-oriented graphics (OOG) development environment. You can create animated picture representations of your process or machine based on discrete or analog values. Objects change size, color, location, orientation, and visibility with respect to their real counterparts.

This chapter provides an overview of GMM. An example is provided that shows you how to create graphic objects and implement animation in your application.

Chapter Contents

<i>Overview of GMM</i>	76
<i>Overview of the Example Application</i>	78
<i>Running the Example Application</i>	78
<i>Viewing the GMM Animation</i>	80
<i>Investigating the GMM Panel</i>	81
<i>Adding a Panel to the Example Application</i>	89
<i>Testing the Example Application</i>	95
<i>Experiment!</i>	96

Overview of GMM

GMM is an Interact software module that runs under control of the Application Manager (AM). GMM allows you to create graphic objects using simple graphic units such as lines, boxes, circles, polygons, arcs, and text. You can connect these objects to variables in your controller, allowing you to create panels that contain animated processes or machine diagrams along with panel tools.

For increased capability, GMM is designed to be used with the Panel Toolkit Module (PTM). See Chapter 5 for more information about PTM.

GMM objects can be dynamically linked to the current application and receive real-time data outputs from a device such as a programmable logic controller.

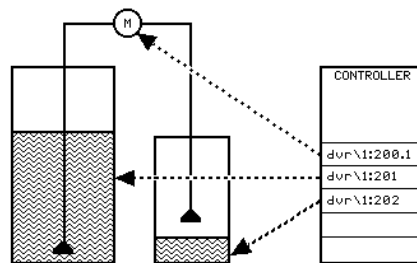

Data can be analog or discrete in nature:

- **Analog** values range continuously between a minimum and maximum value (for example between 0 and 100).
- **Discrete** values are binary in nature. They can have only one of two possible values (for example 0 or 1).

You can configure the objects to change appearance, size, or position when the value of the controller output data changes.

The graphic objects you draw are combined on panels. Each panel is a single screen which contains an assortment of objects representing controller output devices. PTM tools may exist on the same panel as GMM objects.

Example Display

The figures below represent a GMM panel having two tanks linked to output addresses in a controller. The height of the material in the tanks is represented by the patterned areas.

This figure shows the objects when the analog value in the first output address is 80, and the value in the second address is 25:

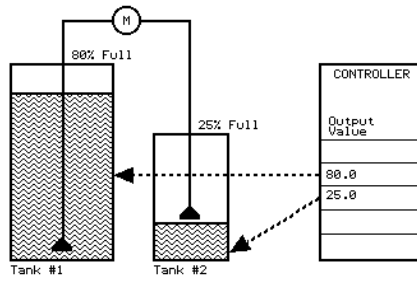

As the controller values change, the heights of the patterned areas change accordingly. When the values reach 40 and 90, the panel appears as shown below:

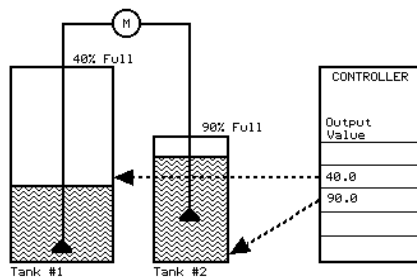

Overview of the Example Application

The following sections provide hands-on experience using the GMM. This example consists of a panel containing an injection molding machine drawn and animated with GMM objects. PTM tools are used to control the animation. As you explore the example application, you will learn to do the following:

- Run the example to see how GMM objects are drawn and animated
- Investigate the GMM panel to learn how animation is created by forming animation connections such as Motion, Position, and Appearance
- Create your own GMM objects
- Run this new panel in Run Mode

Note This example assumes you have the Panel Toolkit Module (PTM) installed on your system and that you are familiar with its operation. If you are unfamiliar with PTM, refer to Chapter 5 of this manual.

Running the Example Application

In this exercise, you will load a panel consisting of GMM objects and PTM tools. In the Run Mode, you will see how PTM tools can be used to animate GMM objects. In an actual application, the animated GMM objects would be controlled by outputs from the control device.

To run the example, follow these steps:

1. Launch Interact from the MachineShop toolbar.
2. On the **File** menu, click **Open Application**.

A list of available projects appears.

3. Double-click the **APPFILES** folder.

The APPFILES folder opens.

4. Click **Gmmexamp**; then, click **OK**.

The Application Browser appears with the Gmmexamp loaded.

5. On the **Run** menu, click **Run Interact**.

6. Click **Yes** when you are asked to save changes.

You enter the Interact Run Mode. The PTM Tools Panel appears.

7. Click the **Trend Scn** button in the upper left of the panel.

The Line Trend panel is displayed.

8. Click the **Select Panel From List** button.

The Panel List, which lists all available panels, is displayed.

9. Click **GMM EXAMPL**.

This panel uses GMM graphics.

10. Click **Accept** to load the GMM example panel.

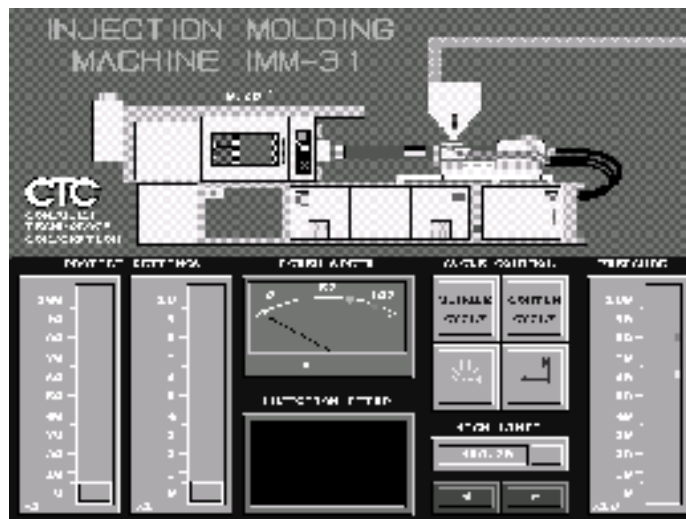

Viewing the GMM Animation

The example panel consists of an injection molding machine drawn with GMM objects. The bottom half of the panel has a number of PTM tools which animate the machine and perform other PTM operations. The injection molding machine has four animated parts:

- Platen and clamp cylinder
- Platen position indicator
- Hopper and screw assembly
- Hopper feed conveyor

To view the GMM animation, follow these steps:

1. Click the left **Slide** tool under Profile Settings up and down. As you do, observe the following GMM animation:
 - The platen and clamp cylinder move in and out (right and left). This illustrates the Motion animation connection.
 - The platen position (in inches) displays above the platen. This illustrates Text animation.
2. Locate the group of four **Cycle Control Push Buttons**:
 - Of the four cycle control buttons, click the **lower right button**. This toggles the hopper and screw assembly in and out (left and right), illustrating the Position animation connection.
 - Of the four cycle control buttons, click the **lower left button**. This toggles the color and pattern of the hopper feed conveyor, illustrating the Appearance animation connection.

The other PTM tools demonstrate PTM functions not linked to GMM.

Note In an actual application, the animated GMM objects could be controlled by outputs from the controller.

Investigating the GMM Panel

In this part of the exercise, you open the GMM module and see how the animation commands are used to animate GMM objects.

To go to the development environment, follow these steps:

1. Click on the **right arrow** Push Button under the High Limit Numeric Entry tool.

The screen returns to the first screen of the application, the Tools PTM panel.

2. Click **Go To AM** to return to the Application Manager Main Menu.

Note You can also get to the Application Manager Main Menu by pressing F10.

3. Click **Exit Interact**; then, click **Accept**.

You will return to the Interact development environment.

4. Double-click on the **Panel Toolkit/Graphics Module (PTM/GMM)** icon.

5. Double-click on the **Panels** icon.

6. Double-click on the **GMM EXAMPL** icon.

The GMM Example panel appears.

7. Click on the **Maximize** button to enlarge your viewing area.

Viewing the Clamp Cylinder Configuration

To examine the clamp cylinder configuration, follow these steps:

1. Click on the **clamp cylinder** (the gray shaft with red end) to select it.

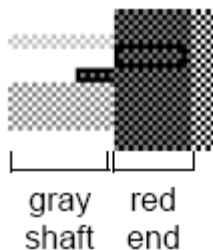

2. Double-click on the **gray shaft** of the clamp cylinder.
The Group property sheet appears as shown below.
3. Click the **Connections** page; then, click the **Motion** page.

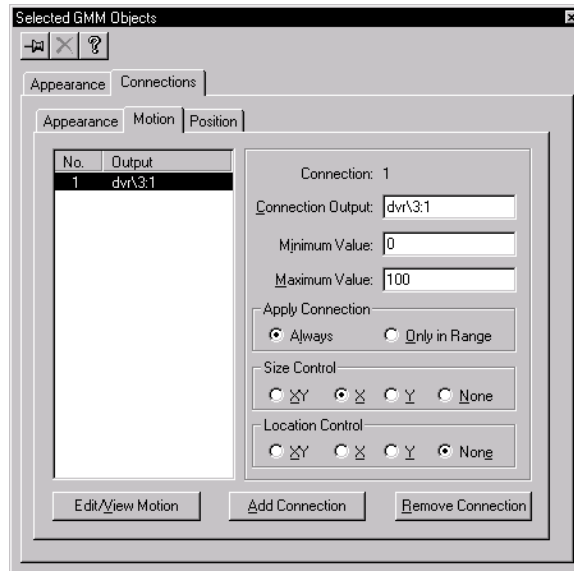

4. Click on **Edit/View Motion**.
The Edit/View Motion dialog box appears as shown below:

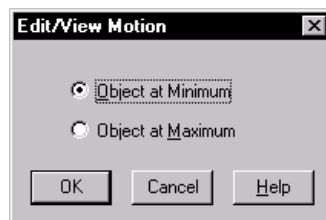

5. Click back and forth on the **Object at Minimum** and **Object at Maximum** buttons.
Notice the changes in position of the clamp cylinder. This is the position of the clamp cylinder at its minimum and maximum positions.
6. Click **Cancel**.

The Group property sheet appears.

Motion connections allow an object to change size and/or move as the data from the address reference varies between minimum and maximum values. The settings are listed below:

- **Connection Output:** dvr\3:1. The controller address to which the object is connected. On the PTM panel, the left Slide control is an input to this same address. Therefore, when you move the Slide, the clamp cylinder changes size.
- **Minimum Value:** 0.000. The minimum value read from the Connection Output address to be used for animation.
- **Maximum Value:** 100.000. The maximum value read from the Connection Output address to be used for animation.
- **Apply Connection:** Always. To use all the values from the controller for animation, not just the values that are in range.

If you select Always, a value greater than the Maximum drives the object to the maximum position. Also, a value less than Minimum drives the object to the minimum position.

If you select In Range, Interact ignores values less than the Minimum or greater than the Maximum. The connection output only affects the object when the data value is within the range specified by the Minimum and Maximum parameter.

- **Size Control:** X. The input changes the size of the object in the X direction. When an object is resized, the upper left hand corner remains fixed. The object increases in size down, and to the right. Since X is selected, the object size can change only to the right.
- **Location Control:** None. Controls the movement of an object. The point of location for an object is the upper left corner of the object.

Note With this connection, as the input changes, the size changes, but the location does not. When an object is resized, the upper left-hand corner remains fixed. The object grows right and/or down.

7. Click off the **Group** property sheet to close the property sheet and return to the GMM/PTM panel.

Viewing the Platen Configuration

To examine the platen configuration, follow these steps:

1. Click on the **clamp cylinder** (the gray shaft with red end) to select it.

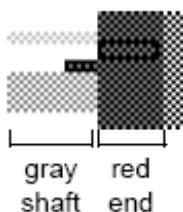

2. Double-click on the **red end** of the clamp cylinder.
3. Click the **Connections** page; then, click the **Motion** page.

Notice the Connection Output is dvr\3:1. This is the same address reference as the clamp cylinder, and both objects are animated by this output. The settings are listed below:

- **Connection Output:** dvr\3:1. The controller address to which the object is connected. On the PTM panel, the Slide control is an input to this same address. Therefore, when you move the Slide, the platen as well as the clamp cylinder changes size.
- **Minimum Value:** 0.000.
- **Maximum Value:** 100.000.
- **Apply Connection:** Always.
- **Size Control:** None. The object does not change size.
- **Location Control:** X. The output changes the location of the platen along the X-axis (left to right).

Note The platen moves as the size of the clamp cylinder changes. Thus, the platen appears to be attached to the end of the clamp cylinder.

4. Click on **Edit/View Motion**.

The Edit/View Motion dialog box appears.

5. Click back and forth between the **Object At Minimum** and **Object At Maximum** buttons.

Notice the changes in the position of the platen. This is the position of the platen at its minimum and maximum positions.

Advanced Information

This motion (location) connection was originally configured in two steps:

1. With **Object At Minimum** selected in the **Edit/View Motion** dialog box, the object was placed in the desired location at the “minimum” input value.
2. With **Object At Maximum** selected in the **Edit/View Motion** dialog box, the object was placed in the desired location at the “maximum” input value.

Now, when you click on **Object at Minimum** or **Object At Maximum**, GMM moves the object according to these original specifications.

6. Click **Cancel**.

The Group property sheet displays.

7. Click off the property sheet to return to the GMM/PTM Panel.

Viewing the Platen Position Indicator Configuration

To examine the Platen Position Indicator, follow these steps:

1. Double-click on the **Platen Position Indicator** (the # signs).



The Text property sheet appears.

2. Click the **Connections** page.

The Appearance page is already in view. This will be an Appearance connection.

Notice `dvr\3:1 /1.98` in the list. This connection is controlled by the PTM Slide tool configured with the same address.

The expression `"/1.98` is a scaling factor applied to the 0-100 input from the slide. The `/" indicates division. Thus the value being read from address DVR\3:1 will be divided by 1.98 and the results will be displayed on the screen. This converts it to 0-50.51 inches for the display.`

With the Text Value box selected, this indicates a text value connection in which the pound characters (#) define a variable field. During operation, the actual input value, scaled by `/1.98`, displays here.

3. Click off the **Text** property sheet to close it and return to the GMM/PTM Panel.

Viewing the Hopper/Screw Assembly Configuration

To examine the Hopper and Screw Assembly, follow these steps:

1. Click the **Hopper And Screw Assembly**.

The entire assembly is enclosed in an invisible box, indicating it is a group object. A single animation connection is applied to this group of objects.

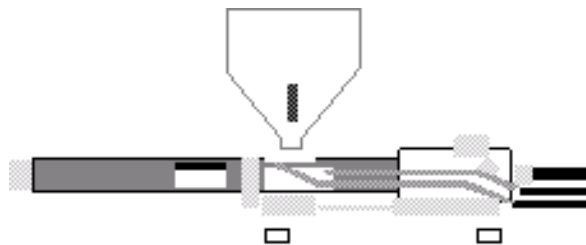

2. Double-click on the **entire assembly** to display the Group property sheet.
3. Click the **Connections** page; then, click the **Position** page.

Notice dvr\4:1.4 in the list. This connection is controlled by the PTM Push Button configured with the same address. Position was chosen rather than motion because the object has only two positions, in and out, with no animation in between.

During operation, the address reference is evaluated as “true” or “false” based upon the status of bit 4 as follows:

- If bit 4 = 0, the address reference evaluates “false.” The connection is **not applied**, and the object remains in the **Original Position** location.
- If bit 4 = 1, the address reference evaluates “true.” The connection is **applied**, and the object moves to the **Connection Position** location.

The settings are:

- **Size Control:** None
 - **Degrees of Rotation:** Zero
 - **Location Control:** X
 - **Mirror Object:** No
4. Click on **Edit/View Position**.

The Edit/View Position dialog box appears as shown below:

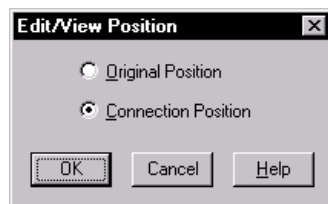

5. Click back and forth between the **Original Position** and **Connection Position** buttons.

Notice the position of the object with and without the connection applied. The object moves to the left at Connection Position. The connection settings are applied to the object when the reference data evaluates as “true.”

Advanced Information

This position connection was originally configured in two steps:

1. With **Original Position** selected in the **Edit/View Position** dialog box, the object was placed in the desired position for the “0” or false output value.
2. With **Connection Position** selected in the **Edit/View Position** dialog box, the object was placed in the desired position for the “not 0” or true output value.

Now, when you click on **Original Position** or **Connection Position**, GMM moves the object according to these original specifications.

6. Choose **Cancel**.

The Selected GMM Objects property sheet displays.

7. Click off the property sheet to return to the GMM/PTM Panel.

Viewing the Hopper Feed Conveyor Configuration

To examine the Hopper Feed Conveyor, follow these steps:

1. Double-click on the **Hopper Feed Conveyor**.



The Polygon property sheet appears.

2. Click the **Connections** page.

The Appearance page is already in view. This is a discrete connection controlled by a PTM Push Button configured with the same address reference.

The Appearance page has commands for setting various attributes of the object. The Foreground Color, Background Color, and Pattern options are selected indicating the connection controls are selected for these parameters.

3. Click on **View Appearance**.

The View Appearance dialog box appears as shown below:

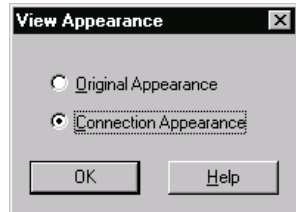

4. Click back and forth between the **Original Appearance** and **Connection Appearance** buttons.

Notice the color and platen change on the hopper feed conveyor. During operation, Interact evaluates the address reference as true or false based upon the status of bit 3 as follows:

5. If bit 3 = 0, the address reference reads “false.” Interact does not apply the connection, and the object maintains its Original Appearance.
6. If bit 3 = 1, the address reference reads “true.” Interact applies the connection, and the object assumes the Connection Appearance state.

- 7.

Advanced Information

This appearance connection was originally configured in two steps:

1. With **Original** selected in the **View Appearance** dialog box, the object was originally drawn and given a **Foreground Color**, **Background Color**, and **Pattern** for the “0” or false output value.
2. With **Connection Appearance** selected in the **View Appearance** dialog box, the object was defined at the “not 0” or true output value.

Now, when you click on **Original** or **Connection Appearance**, GMM changes the object appearance according to these original specifications.

8. Choose **OK**.
9. The Polygon property sheet displays.
10. Click off the property sheet to return to the PTM/GMM Panel.
11. You are finished examining the existing GMM panel.

Adding a Panel to the Example Application

In this part of the example, you will enter the development environment and add tools to a panel. These tools are configured so you can understand how a panel is created. This example assumes you know how to configure PTM tools. If this is not the case, review the PTM example in Chapter 5.

In this exercise, you will learn to do the following:

- Create new PTM tools
- Create new GMM objects
- Link the two panels in the PTM Panel List
- Animate the panel in the Run Mode

Creating a New Panel

To create a new panel, follow these steps:

1. Double-click on the **Panel Toolkit/Graphics Module (PTM/GMM)** icon in the Application Browser window.
2. Double-click on the **Panels** icon.
3. Double-click on the **New** icon.

A blank PTM panel appears.

4. Click on the **Maximize** button to maximize your viewing window.

Creating PTM Tools

Place the following PTM tools along the bottom of the panel you just created:

1. A **Load Panel** Action Button.
2. A **Maintained Push Button**. Use **dvr\4:300.1** as the **Switch Input** address, and enter **OFF** as the **Lens Label**.

3. A **Slide** tool. Use **dvr\3:300** for the **Slide Input** address, and use a **Minimum Value** of 0 and **Maximum Value** of 100.

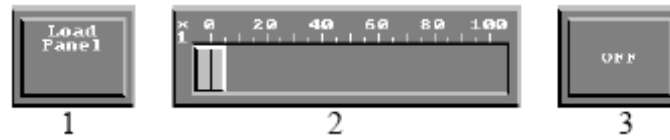

Creating GMM Objects

To add graphics to your PTM Panel, follow these steps:

1. Draw a rounded rectangle above the PTM tools. Do this by clicking on the **Round Rectangle** icon in the **GMM Graphics Box** located at the bottom of the screen. Draw the rectangle to the size shown below.
2. Double-click on the **Rounded Rectangle** object just created.
The Rounded Rectangle property sheet appears.
3. Click on **black** in the Foreground Color box.
4. Click on **Wire Frame** in the Pattern box.

The Rounded Rectangle object changes from a solid figure to an outline.

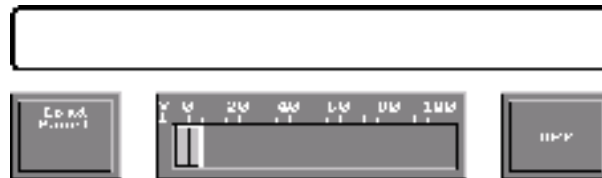

5. Click on one of the larger sized lines in the **Line Width** box.
6. Click off the property sheet to close it and return to your panel.
7. Click on the **Ellipse** icon in the GMM Graphics Box.
8. Draw a circle on the left side of the rectangle as shown below.

Note If you push the Ctrl key while drawing the ellipse, you will draw a perfect circle.

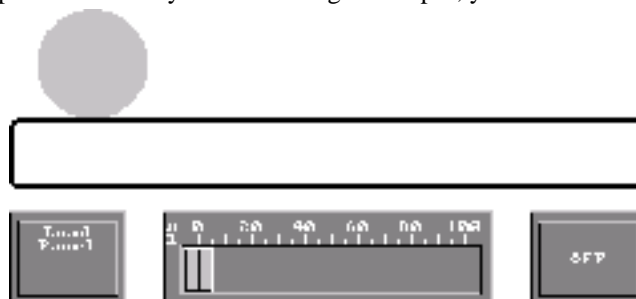

9. After drawing the ball, if you must resize or move it, click on the **Selection Mode** button (selector arrow) on the **Toolbar**. Click on the ball you drew to bring up the selection tabs to either resize or move the ball.

10. Double-click on the **ball** you just created.

The Ellipse property sheet appears.

11. Click on a pattern with diagonal lines in the **Pattern** box.

12. Click on a light green color for the ball in the **Background Color** box.

13. Click off the property sheet to close it.

Note You cannot place a PTM tool over a GMM object. Interact places all PTM tools on a layer behind the GMM layer, so you cannot change the order by simply bringing a PTM tool forward.

The only way to achieve the same effect is to draw all your GMM objects first. Make sure you have them exactly the way you want them. Then save the screen as a background (Edit, Background, Save Image). Open a new panel, and select the background you just saved (Edit, Background, Select Image). You can now place your PTM tools over the GMM image.

Applying Animation Connections to the Ball

The ball will have two different animation connections:

- Motion
- Appearance

Applying a Motion Connection

To apply motion connections, follow these steps:

1. Double-click on the ball.

The Ellipse property sheet appears. When completely configured, the Selected GMM Objects property sheet appears as shown below:



2. Click the **Connections** page; then, click the **Motion** tab.
3. Click the **Add Connection** button.
4. Click the **Connection Output** box.

The Address Reference dialog box appears.

5. Type **dvr\3:300** in the Address Reference dialog box.
6. Click **OK**.

Notice that the address reference you just entered now appears next to No. 1 in the list on the left side of the Motion page.

7. Enter **100** in the Maximum Value box.
8. Click the **X** option in the Location Control box.

This will allow the ball to move only along the X-axis.

9. Click on the **Edit/View Motion** button.
10. Click **Object at Maximum**.
11. Drag the ball to the other end of the rectangle.

This sets the position for the object when the output is at its maximum value (100).

12. Click on **Object at Minimum**.

The ball returns to its original position. In Run Mode, Interact will animate the ball at all locations in-between.

13. Click **OK**.

Applying an Appearance Connection

To apply appearance connections, follow these steps:

1. From the **Connections** page, click the **Appearance** page.
2. Click on the **Add Connection** button.
3. Click the **Connection Output** box.

The Address Reference dialog box appears.

4. Type **dvr\4:300.1** in the Address Reference dialog box.
5. Click **OK**.
6. Click the **Background Color** box and choose **red**.
7. Click the **Pattern** box, and choose a different pattern from the original.
8. Click on the **View Appearance** button.

The View Appearance dialog box appears.

9. Click back and forth between the **Original Appearance** and **Connection Appearance** buttons.

Notice how the appearance of the ball changes. The Connection Appearance shows how the ball will appear when the bit 300.1 is evaluated as “true.”

10. Click **OK**.

11. Click off the property sheet to close it.

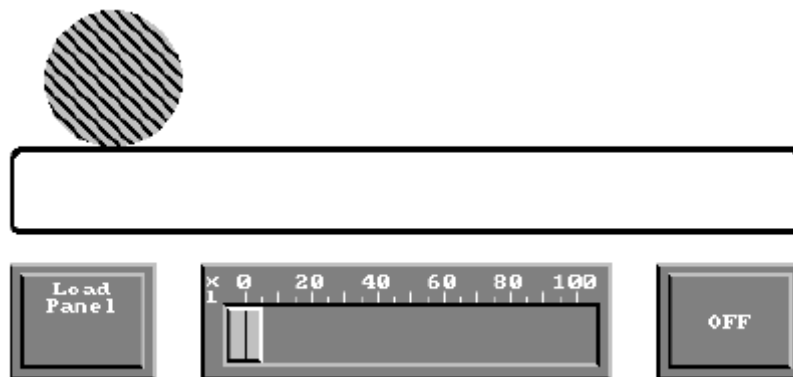

Saving the GMM Objects

To save the GMM Objects, follow these steps:

1. On the **File** menu, click **Save Panel As**.

The Save As dialog box appears.

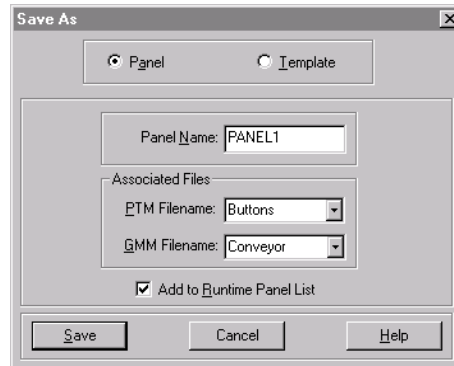

2. Enter PTM and GMM File names as shown above.

Notice the Panel Name is PANEL 1.

3. Make sure the **Add to Runtime Panel List** option is selected.
4. Click **Save**.

Testing the Example Application

Once you have saved the GMM objects, you are ready to test the modified example application.

Returning to Run Mode

To return to Run Mode, follow these steps:

1. On the **Window** menu, click **Application Browser: gmmexamp**.

The Application Browser window becomes active.

2. From the **Application Browser**, click the **Application Manager** icon.
3. On the **Run** menu, click **Run Interact**.
4. Click **Yes** when you are asked to save changes.
5. Go to the **Trend Screen** by clicking on the **Trend Scn** button in the upper left of the panel.
6. Click on **Select Panel From List**.
7. Load the panel "**Panel 1**" by highlighting it and then clicking **Accept**.

Panel 1 is a combination of the PTM and GMM objects you created, as shown on Click off the property sheet to close it..

8. Click on the **Push Button**.

Since this is a Maintained Push Button, it remains On. Note how the appearance of the ball changes.

9. Click on the **Slide** tool tab, and drag the slide to **50**.

Note how the ball moves along the rectangular conveyor.

10. Continue moving the slide to **100**.
11. Click on the **Load Panel** button, and choose **Tools** to exit this panel.
12. Click on **Go To AM** to return to the **Application Manager**.
13. Click **Exit Interact**; then, click **Accept**.

The Application Manager window appears.

Experiment!

This chapter provides only a brief introduction to the features of GMM. The best way to learn is to experiment.

- Add additional connections to the panel you created in this chapter.
- Create the panel shown below; then, animate it.
- Use the Motion connection to change the level of the liquid in the tanks.
- Use a PTM Slide tool to transfer liquid from one tank to the other.
- Add high and low limit switches using the appearance connection.

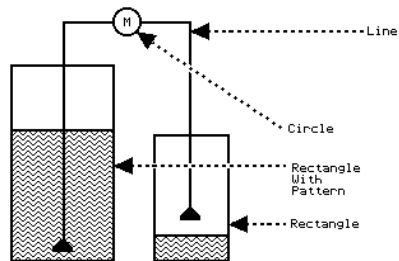

Alarm Management Module

The Alarm Management Module (AMM) allows you to define alarm conditions and define corresponding reporting, logging, and corrective action procedures. AMM has five different levels of alarm priority that can be programmed to require certain user access levels to disengage or recognize alarms.

This chapter provides an overview of AMM. An example is provided that shows you how to set up an alarm configuration and incorporate alarm functions into your application.

Chapter Contents

Overview of AMM	98
Important Concepts	99
Overview of the Example Application	102
Running the Example Application	102
Triggering an Alarm	103
Clearing Alarms	107
Inhibiting a Group of Alarms	107
Adding an Alarm to the Example Application	109
Testing the Example Application	114
Experiment!	114

Overview of AMM

The Alarm Management Module (AMM) is an optional software module that runs under the Interact Application Manager (AM). AMM is used to automatically and continuously:

- Monitor conditions within process parameters
- Present alarm information to an operator when these conditions are out of tolerance

Detected alarm conditions appear on an Alarm Summary Display. An alarm is shown as a line of text which has attributes such as:

- The time and date the alarm was triggered
- The time and date the alarm went inactive
- The time and date the alarm was acknowledged
- A description of the alarm condition
- The alarm priority level
- Alarm Value (the data value when the alarm was detected)
- Current Value (the data value updated in real-time)
- The name of the group to which the alarm belongs
- The name of the operator who acknowledged the alarm

In the development environment, AMM enables you to configure alarms and their corresponding parameters for unique process requirements by:

- Creating new alarms
- Editing existing alarms
- Deleting existing alarms
- Configuring the Alarm Displays which the operator uses during Run Mode
- Configuring the alarm history file and printer settings

In Run Mode, AMM continuously monitors the designated process variables for out-of-tolerance (alarm) conditions. When an alarm condition exists, AMM automatically:

- Alerts the operator
- Provides information on the alarm condition
- Enables the operator to acknowledge the alarm

- Directs the operator to take corrective action
- Lets the operator comment on the conditions and the corrective actions taken

AMM can also do the following:

- Automatically produce printed reports and alarm logs on disk for problem investigation and record keeping
- Allow override and adjustment of alarm conditions by personnel having the correct user level
- Provide alarm information to other Interact modules such as PTM

An optional alarm message can be attached to an alarm object if more detailed information is needed.

In Run Mode, alarm information displays in a standard format that shows a large number of alarm points at one time. Normally, just the basic attributes of the alarms and real-time data values are displayed. The operator can “expand” individual alarm points to view optional alarm messages if these are configured.

Important Concepts

The following are important concepts you will need to know as you use AMM.

Alarm Priorities

All alarms must be assigned to one of five priorities numbered 1 through 5. Priority 1 is the lowest priority and 5 is the highest.

Note All alarms assume Priority 3 by default.

This priority number is used in Run Mode to selectively display and/or acknowledge alarms. For example, you can configure AMM to force an operator to acknowledge all priority 5 alarms individually instead of all at once.

Priorities may be assigned names which provide the operator with useful information. The priority name is optional and can be between 0 and 8 characters long.

The default names are listed below:

Priority #	Priority Name
1	Notice (Lowest)
2	Warning
3	Alert
4	Urgent
5	Critical (Highest)

You can specify whether priority number will invoke the alarm annunciation procedure, the method by which AMM notifies the operator of an alarm. If you specify No Annunciation, the alarm is just displayed on the screen, logged, and sent to the printer (if so configured). Alarms configured for No Annunciation need not be acknowledged.

Acknowledging Alarms

You can acknowledge alarms one of two ways, depending on how AMM is configured:

- All at once (within a specific alarm priority level)
- Individually

You acknowledge alarms by pressing the Acknowledge button located on the Alarm Summary Display in Run Mode.

You might want to configure AMM to require individual acknowledgment of critical alarms to force the operator to examine each alarm before acknowledging it. An example of how you might configure AMM is listed below:

- Priorities 1 through 4 for Acknowledge All
- Priority 5 for Acknowledge Individual

Acknowledgment User Level

Each Priority can be assigned an Acknowledgment User Level. This feature can be used to prevent unauthorized personnel from acknowledging high priority alarms. Within Interact there are six user levels (0 through 5) with 5 providing the least privileges and 0 the most.

Alarm Groups

All alarms must be assigned to a group. Groups allow alarms to be separated into sets which share something in common:

- All alarms on the same machine
- All alarms of a given priority
- All alarms related to the same process or function

A typical use for alarm groups is to assign the alarms from each machine to separate groups. In Run Mode, the operator can enable or inhibit an entire group of alarms at once. This allows you, for example, to inhibit the alarms from a machine when that machine is taken off-line for maintenance.

Note Alarms not assigned to a group are automatically assigned to the default group “Global.” A group can contain alarms of different priorities.

Sending Alarm Information to Another Module

AMM can send alarm information to other Interact modules. For example, the Panel ToolKit Module (PTM) can be configured to display alarm messages and acknowledge alarms. To enable this capability, you must configure the Remote Alarm Controls Setup property sheet. You then reference AMM’s reserved “Link Variables” from PTM.

Key Assignments

Alarm display components (buttons, etc.) can be assigned keyboard keys. Pressing an assigned key (or keys) will perform the assigned operation. For example, pressing F1 might perform the same operation as clicking the Acknowledge button with the left mouse button.

During configuration of the Alarm Summary, Alarm Control, or Alarm History Displays, you can change the default key assignments to any other key on the keyboard.

The function keys F1 through F10 can be used together with the Shift, Ctrl, and Alt keys to provide forty function key assignments. The table below lists possible key assignments.

Pressing these keys	Assigns these functions
F1 through F10	F1 through F10
Shift+ F1 through F10	F11 through F20
Ctrl+ F1 through F10	F21 through F30
Alt+ F1 through F10	F31 through F40

Alarm Runtime Displays

AMM includes a series of Alarm Displays that are used during runtime to view and control alarm information. You can configure the appearance of these screens in the development environment using the Runtime Display command on the Settings Menu. You can also configure the Backup popup displays and the Print History popup display.

Overview of the Example Application

The following sections provide hands-on experience with alarms using AMM. This example consists of an application, Ammexamp, which contains several alarms and a panel created in PTM. You will explore the example application in several ways:

- Load the example application and view the Alarm Summary Display and the example panel
- Trigger several alarms and observe the results
- Acknowledge and clear the alarms
- Turn off audible annunciation
- Inhibit a group of alarms, trigger the alarms, and observe the results
- Create an alarm using AMM
- Test the modified application

Note This example assumes you have the Panel Toolkit Module (PTM) installed on your system and that you are familiar with its operation. If you are unfamiliar with PTM, refer to Chapter 5 of this manual.

Running the Example Application

To run the example, follow these steps:

1. Launch Interact from the MachineShop toolbar.
2. On the **File** menu, select **Open Application**.

A list of available projects appears.

3. Double-click the **APPFILES** folder.

The APPFILES folder opens.

4. Click **Ammexamp**; then, click **OK**.

The Application Browser appears with the Ammexamp application loaded.

5. On the **Run** menu, select **Run Interact**.

You enter the Interact Run Mode, and the PTM panel designed for this example appears as shown below.

Note This application was configured to go into Run Mode when the Run Interact option is selected. Use the Startup Mode parameters configured on the Application Settings property sheet to configure which runtime mode, module, and startup user will be active upon entering Run Mode. For this application, the PTM panel designed for this example is the first Run Mode screen displayed.



Triggering an Alarm

In a real application, conditions in your actual process will trigger the alarms. However, in this example, you will manually trigger the alarms from a PTM panel.

Now you will trigger an alarm from the example panel and then view the result on the Alarm Summary Display. You will trigger the alarm using the Horizontal Slide tool at the bottom of the screen. A value between 30 and 70 will trigger an alarm.

To trigger an alarm, follow these steps:

1. Move the slider on the **Horizontal Slide** tool to an approximate value of 40.

An alarm is triggered and begins beeping an audible alert.

2. Click **Acknowledge Alarms** to acknowledge the currently selected alarm.

The beeping stops, indicating the alarm has been acknowledged. Notice the Alarm Conditions display indicates that one alarm condition exists. Also, a message is displayed in the Alarm Messages window.

3. Click **Go To Alarm Module**.

The Alarm Summary Display appears and a row of information about the alarm is displayed. The text for this alarm is red. The up and down arrows along the right edge of the display are scroll buttons.

4. Click the **Down Arrow** button to scroll the alarm into the dotted capture area at the top of the display.

A message corresponding to this particular alarm appears in the Alarm Message Window located at the upper right of the screen.

5. Click **Expand Message** to increase the size of the window and view the message in its entirety.
6. Once you have read the entire message, click **Expand Message** again to return the window to its normal size.

Turning Off Audible Annunciation (Optional)

Before triggering more alarms you may turn off audible alarm annunciation, since this is just a practice session. If you wish to keep the audible 'beeping' enabled, skip to the Triggering More AI section.

To turn off audible alarm annunciation, follow these steps:

1. Click **Alarm Control** located at the upper right of the screen.
2. Click **Audible On** located at the bottom of the screen.

The label on the button changes to Audible Off. Alarms will no longer beep.

3. Click **Alarm Summary** located at the upper right of the screen.

The Alarm Summary Display appears.

Triggering More Alarms

Now you will trigger several more alarms to see how AMM handles multiple alarms. As each alarm is activated, observe the changes to the tools on the PTM panel.

To trigger multiple alarms, follow these steps:

1. Click the **left arrow** in the lower left corner of the **Alarm Summary Display**.

The example panel appears.

2. Click the **Up Arrow** button, next to the **Panel Meter** tool, until the needle points to a value of **6**.

A value greater than 4 will trigger an alarm.

3. Click the **Alarm** button.

This is a Momentary Push Button which triggers an alarm when pressed.

4. Drag the slider on the **Vertical Slide** tool to a value of **6**.

An input value greater than 5 will trigger an alarm. Return to the Alarm Summary Display to see how the alarms were reported.

5. Click the **Go To Alarm Module** button.

The Alarm Summary Display appears.

- Click the **Up Arrow** button until none of the alarms are highlighted.



Notice that four alarm conditions are present. The Vert. Slide and Panel Meter alarms are blinking. This indicates these alarms have not been acknowledged.

- Click the **Acknowledge** button, which is also blinking, to acknowledge the alarms.

The Button Entry alarm is the only alarm which is inactive, meaning the alarm condition no longer exists. An inactive alarm is indicated in two ways: the color of the row is gray, and the Alarm Value field displays "Inactive."

The alarms are listed on the Alarm Summary Display according to the time at which they occurred. They can also be listed by priority level, from highest to lowest priority. To do this, complete the following steps:

- Click the **List Priority** button located at the bottom of the screen.

The alarms are listed by priority with the most critical alarms listed at the top of the display. Also, the button label changes to List By Time.

2. Click the **List By Time** button located at the bottom of the screen.

The alarms are rearranged according to time with the most recent alarms at the top of the screen. Also, the button label changes to List By Priority.

Clearing Alarms

An alarm must be inactive before it can be cleared. Depending on the Clear Alarms button settings, the alarm may also have to be acknowledged and viewed before it can be cleared.

To clear alarms, follow these steps:

1. Click the **Clear Alarms** button located at the bottom of the Alarm Summary Display.

Notice that the only alarm which clears is the Button Entry alarm, because it is the only inactive alarm. Before we can clear the other alarms, we must remove the alarm conditions.

2. Click the **Left Arrow** button in the lower left corner of the display to go to the example panel.
3. Change the values on the **Meter, Horizontal Slide** tool, and **Vertical Slide** tool to **0**.
4. Click **Go To Alarm Module** button.

The Alarm Summary Display appears. All alarms are now inactive, since the alarm conditions no longer exist.

5. Click **Acknowledge**.
6. Click **Clear Alarms** located at the bottom of the Alarm Summary Display.

The alarms are cleared.

Inhibiting a Group of Alarms

When you create an alarm, you may assign it to a group. Typically this would be a group of related alarms associated with one machine or process. AMM allows you to use groups in two powerful ways. First, you can inhibit/enable alarms by group. Second, if you are logging alarm activity, you can view the alarm history (logged files) by groups of alarms.

In this example, the alarms are assigned to one of two groups, Level 1 or Level 2, and all alarms are currently enabled. You will inhibit Level 2 alarms.

To inhibit a group of alarms, follow these steps:

1. Click the **Alarm Control** button located in the upper right corner of the Alarm Summary Display.

The Alarm Control Display appears. “Level 1” is shown under the Control Group area in the upper left corner, and the alarms assigned to the Level 1 group are listed in the main area of the display.



2. Click the **right arrow** button in the Control Group area.

Level 2 displays as the current group, and the alarms assigned to Level 2 are listed.

3. Click the **Enabled** button in the Control Group area to inhibit the alarms in Level 2.

The color of the alarms change to gray, and the line to the right of the time display reads “Level 2 Group: Inhibited.” Now you will go back to the example panel, trigger some alarms, and see what happens.

4. Click the **left arrow** button located in the lower left of the Alarm Control Display.

The example panel appears.

5. Move the slider to change the value on the **Horizontal Slide** tool to a value between **30** and **70**.
6. Click the **Up Arrow** button to change the value on the **Panel Meter** tool to a value greater than **4**.
7. Click the **Alarm** button.
8. Move the slider to change the value on the **Vertical Slide** tool to a value greater than **5**.
9. Now you will go to the Alarm Summary Display to see how the alarms were reported.
10. Click **Go To Alarm Module**.

The Alarm Summary Display appears. The Button Entry and Vert. Slide alarms are the only alarms listed.

There are also alarm conditions for the Panel Meter and Horizontal Slide, but since they are both assigned to Level 2, which is inhibited, no alarms were triggered. You do not need to clear alarms before exiting this example.

Adding an Alarm to the Example Application

In this part of example, you will learn to do the following:

- Create an alarm in the development environment
- Test the alarm by triggering it from the example panel and observing the results

Returning to the Development Environment

To return to the development environment, follow these steps:

1. Click **Go To AM**, located at the lower right of the Alarm Summary Display, to return to the Application Manager Main Menu.
2. Click **Exit Interact**; then, click **Accept**.

The Interact Application Manager window is displayed.

Creating a New Alarm

You will add a second alarm condition to the Vertical Slide tool. Currently, an alarm is triggered at a value greater than 5. The alarm we create will be triggered at a value greater than 8.

There are two ways to enter a new alarm: entering all new information for a new alarm or copy, paste, and edit an existing alarm. For this example, you will copy Alarm 2, the existing Vertical Slide alarm, and edit it.

To create a new alarm, follow these steps:

1. Double-click on the **Alarm Management Module (AMM)** icon in the Application Browser.
2. Double-click the **Alarm Definitions** icon.

The Alarm Definitions window appears. The four alarm definitions from the example application are listed as shown below:

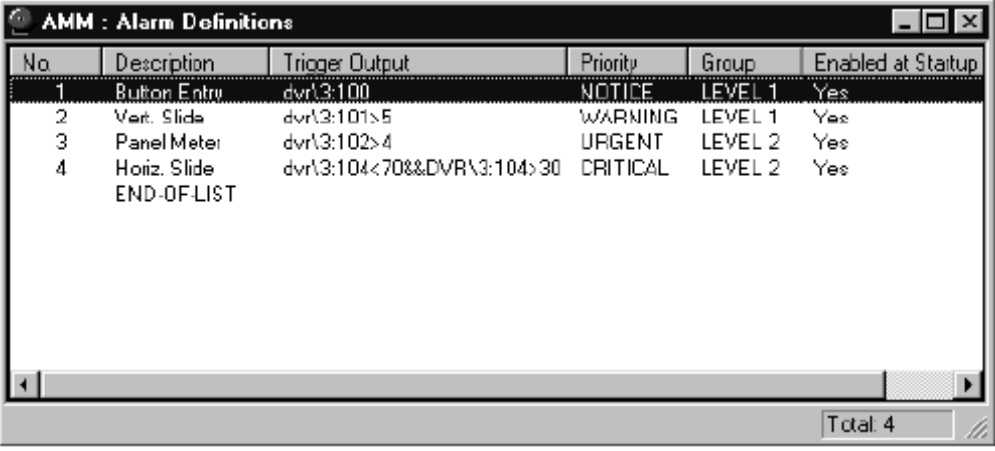

No	Description	Trigger Output	Priority	Group	Enabled at Startup
1	Button Entry	dvr\3:100	NOTICE	LEVEL 1	Yes
2	Vert. Slide	dvr\3:101>5	WARNING	LEVEL 1	Yes
3	Panel Meter	dvr\3:102>4	URGENT	LEVEL 2	Yes
4	Horiz. Slide	dvr\3:104<70&&DVR\3:104>30	CRITICAL	LEVEL 2	Yes
	END-OF-LIST				

Total 4

3. Click on alarm definition number 2, the Vert. Slide alarm. The entire row is highlighted.
4. On the **Edit** menu, select **Copy**, or click the **Copy** button on the Toolbar.
5. Click on **End of List** in the **Alarm Definitions** window.

The entire row is highlighted.

6. On the **Edit** menu, select **Paste**, or click the **Paste** button on the Toolbar.

The copied alarm now appears as alarm No. 5, which is highlighted. You will now edit this alarm.

- On the **Edit** menu, select **Edit Alarm**. The **Alarm Definition** property sheet appears.

Note An alternate means of editing an alarm is to simply double-click on the alarm definition in the Alarm Definitions window.

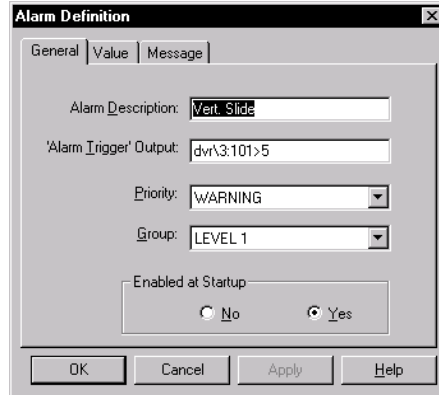

- Type **2** at the end of the description in the **Alarm Description** box so that the new entry reads **Vert. Slide 2**.
- Click the **Alarm Trigger Output** box.

The Address Reference dialog box appears with the address listed in the box.

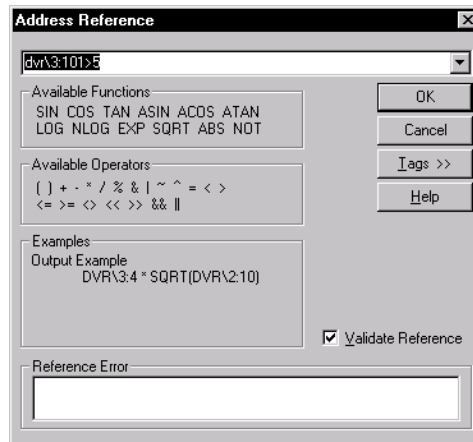

- Change the **5** to an **8**, so the entry reads: **dvr\3:101>8**.

Now a new alarm will be triggered when the value at location 3:101 is greater than 8.

- Click **OK**.

The Alarm Definition property sheet is displayed.

12. Select **Level 2** from the Group box.

13. Click the **Message** page of the Alarm Definition property sheet.
14. Click **Edit**.

The Alarm Message Window is displayed.

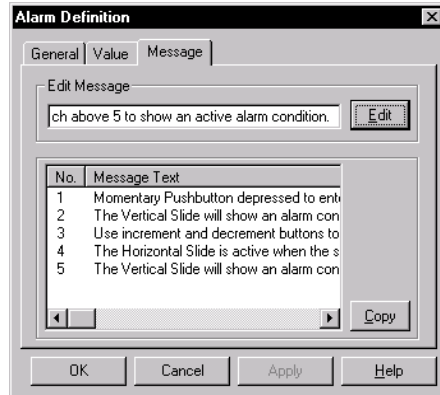

15. Change both **5s** to **8s** so the message field reads:
“The Vertical Slide will show an alarm condition when moved above 8. Keep slide switch above 8 to show an active alarm condition.”
16. Click outside the window to close the window and save changes.
17. Click **OK**.
18. Close the **Alarm Definitions** window.
19. On the **File** menu, select **Save Alarms**.
20. Click **Yes**.

Testing the Example Application

Once you have created and saved an alarm, you are ready to test the modified example application.

Returning to Run Mode

To return to Run Mode, follow these steps:

1. From the **Application Browser**, click the **Application Manager** icon.
2. On the **Run** menu, select **Run Interact**.
3. Click **Yes** when you are asked to save changes.

The PTM example panel appears.

4. Move the slider on the **Vertical Slide** tool to a value of **10**.

An alarm is triggered and begins beeping an audible alert.

5. Click the **Go To Alarm Module** button.

The Alarm Summary Display appears.

6. Click the **Acknowledge** button to acknowledge the alarm.

This will cause the alarm items to stop blinking.

7. Click on **Go to AM**, located at the bottom right of the screen, to return to the Application Manager Main Menu.

8. Click **Exit Interact**; then click **Accept** to return to the development environment.

Experiment!

This chapter provides only a brief introduction to the features of AMM. The best way to learn is to experiment.

- Practice inhibiting/enabling groups of alarms and individual alarms.
- Create additional alarms for another tool like you did for the Vertical Slide.
- Configure the Acknowledge button on the Alarm Summary Display to acknowledge alarms by priority.
- Configure the Next Alarm button on the Alarm Summary Display to view alarms by priority.

Data Transfer Module

The Data Transfer Module (DTM) allows you to exchange data between multiple device drivers. DTM provides a solution to expensive networking software and hardware with inexpensive software connections. There is no limit to the number of device drivers that can be used with DTM, and there is no extra hardware required.

This chapter provides an overview of DTM. You will learn to create an example application that shows you how to transfer data directly between controllers.

Chapter Contents

<i>Overview of DTM</i>	116
<i>Creating an Example Application</i>	117
<i>Designing a PTM Panel</i>	120
<i>Configuring DTM</i>	124
<i>Testing the Example Application</i>	126
<i>Experiment!</i>	127

Overview of DTM

The Data Transfer Module (DTM) is a software program used with the Interact product. It provides a method of transferring data between device drivers used in your Interact application. This module is typically used to pass data between different controllers.

DTM is provided as a module that runs under the control of the Interact Application Manager (AM). The Data Transfer Module/Application Manager block diagram is shown below.

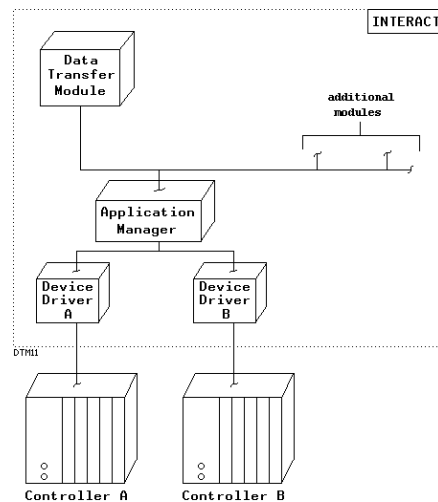

The following list is a summary of DTM features:

- You can configure Interact applications to transfer data between device drivers.
- You can assign data transfers to groups.
- You can form a group from any collection of data transfer items. For instance, all discrete data items can be grouped together.
- You can control individual groups to enable or disable data transfers.
- You can load, save, or print data transfer configurations.

You can see a diagram of data transfers between controllers below. This graphic illustrates DTM taking data from controller X (output reference) and transfers it to controller Y (input reference).

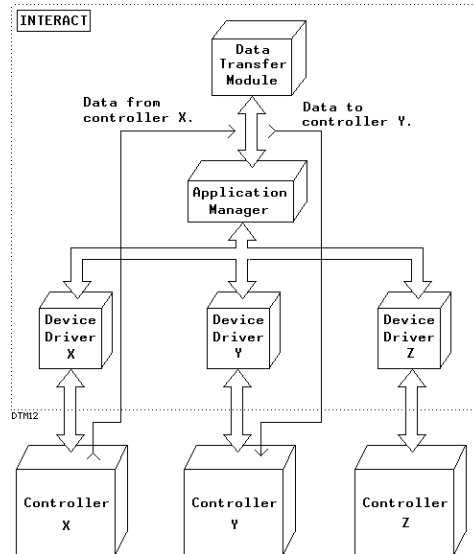

During Run Mode, DTM uses the configuration of data transfers and group assignments to perform the transfers in the background. We have not associated a runtime display with DTM.

Creating an Example Application

The following sections provide hands-on experience with transferring data between fictitious controllers using the Data Transfer Module (DTM).

DTM does not use any runtime screens. There is no example application that is shipped with Interact. You must create the application yourself. In this example you will learn to do the following:

- Create an application using the Data Transfer Module (DTM), the Panel Toolkit Module (PTM), and two Demo Drivers (DVR)
- Rename each of the Demo Drivers TI (Texas Instruments) and AB (Allen-Bradley) to allow simulation of two PLC drivers
- Design a PTM panel to display the data transfers in runtime
- Configure DTM to send data from the TI driver to the AB driver
- Run the application and view the transfers taking place on the PTM panel

Note This section assumes you have the Panel Toolkit Module (PTM) installed on your system and that you are familiar with its operation. If you are unfamiliar with PTM, refer to Chapter 5 of this manual.

Creating an Application

To create an application, follow these steps:

1. Launch Interact from the MachineShop toolbar.
2. On the **File** menu, click **New Application**.

The New Application dialog box appears.

3. Type **Dtmexamp** in the Application Name box.
4. Click **OK**.

The Application Browser appears.

Assigning the Modules and Drivers

1. Double-click the **Modules Used** icon in the **Application Browser**.
2. The Modules Used dialog box appears.

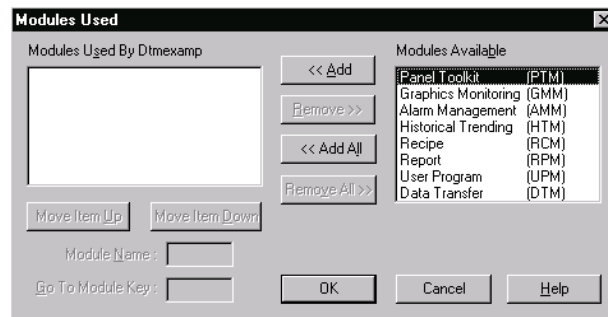

3. Add PTM and DTM to this application:

Click **Panel Toolkit (PTM)** in the Modules Available list.
Click **Add**. PTM is now listed in the Modules Used By list.
Click **Data Transfer (DTM)** in the Modules Available list.
Click **Add**. DTM is now listed in the Modules Used By list.

Click **OK**.

4. Double-click the **Drivers Used** icon in the Application Browser.

5. The Drivers Used dialog box appears.

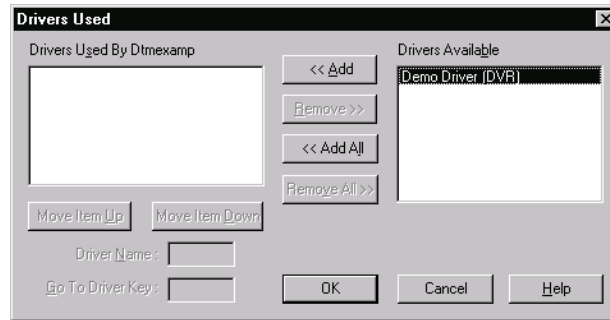

Drivers are added to applications the same way as Modules. Add the Demo driver to this application twice:

Click **Demo Driver** in the Drivers Available list.

Click **Add**. The driver is now listed in the Drivers Used By list.

Click again on **Demo Driver** in the Drivers Available list.

Click **Add**. The **Demo Driver** is now listed twice in the Drivers Used By list.

Notice that the second driver is listed as Demo Driver (DVR0). The names DVR and DVR0 indicate that the two Demo drivers are unique.

6. Rename the drivers TI and AB:

Click on **Demo Driver (DVR)** in the Drivers Used By list.

Type **TI** in the Driver Name text box located below the Drivers Used list.

Click on **Demo Driver (DVR0)** in the Drivers Used By list.

Type **AB** in the Driver Name text box located below the Drivers Used list.

The Drivers Used dialog box on your screen should look like this:

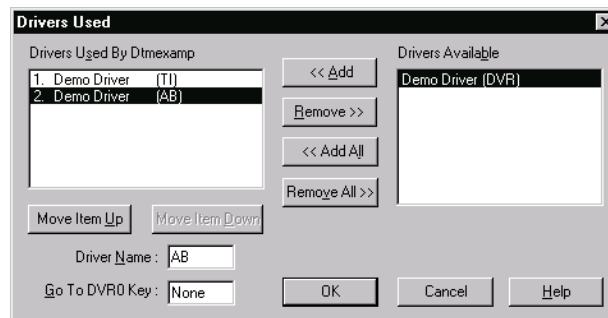

7. Click **OK**.

The two demo drivers will appear in the Application Browser window.

Designing a PTM Panel

Next you will build a PTM panel. One side of the panel will contain tools tied to the TI driver. The other side of the panel will be dedicated to tools tied to the AB driver. It is important to note that both of these drivers are the Demo driver which you have renamed TI and AB.

TI Tools

To configure the TI tools, follow these steps:

1. Double-click on the **Panel Toolkit Module (PTM)** icon in the Application Browser.
2. Double-click on the **Panels** icon.
3. Double-click on the **New** icon.

A new PTM panel window appears. When this section is completed the panel should resemble the one shown below.

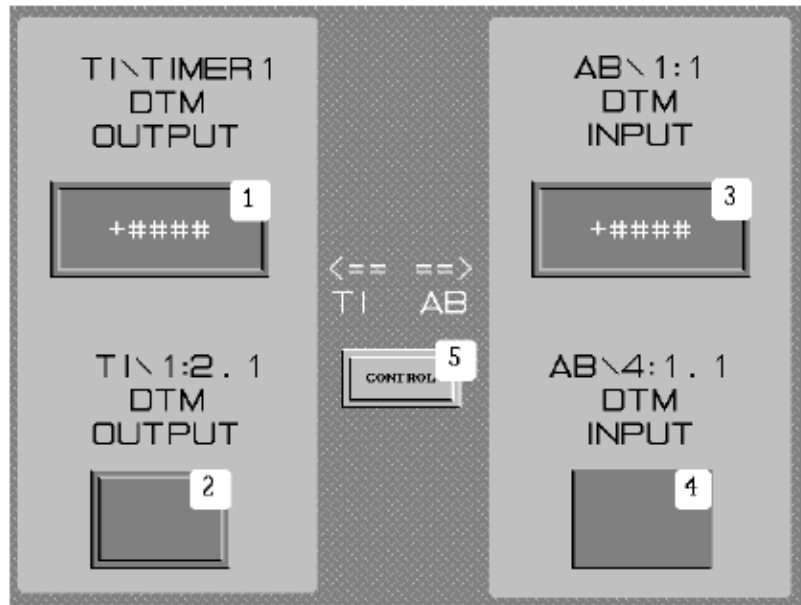

Note The numbers labeling each tool will not appear. The numbers are for the purpose of this exercise only. Do NOT add these numbers. All tools are created using the PTM tool buttons located along the right edge of the PTM window. To distinguish which buttons are tied to which tools, place the cursor over a button and a Tool Tip will appear displaying the name.

4. Create tool #1. This tool is a Numeric Display. Size and place this tool on the screen as shown above.

5. Double-click the **Numeric Display** tool.

The Numeric Display property sheet appears.

6. Enter the following settings for the Numeric Display on the **Settings** page:

- **Field Size:** 4
- **Display Value Output:** Ti\timer1

Note Clicking the Display Value Output box displays the Address Reference dialog. Type the address in the box, and click OK.

7. Click the **Appearance** page.

8. Enter the following settings for the Numeric Display on the **Appearance** page:

- **Tool Color:** gray
- **Font:** eurostyl

9. Click **outside** the Numeric Display property sheet to close it.

10. Create tool #2. This tool is a Push Button. Size and place this tool on the screen as shown in the figure on .

11. Double-click the **Push Button** tool.

The Push Button property sheet appears.

12. Enter the following settings for the **Push Button**:

- **Type:** Maintained Button
- **Switch Input:** Ti\1:2.1

Note Clicking the Switch Input box displays the Address Reference dialog box. Type the address in the box, and click OK.

13. Click **outside** the Push Button property sheet to close it.

If you desire, you can place Panel Labels as shown in the figure on .

AB Tools

To configure the AB tools, follow these steps:

1. Create tool #3. This tool is another Numeric Display. Size and place this tool on the screen as

shown in the figure on .

2. Double-click the **Numeric Display** tool.

The Numeric Display property sheet appears.

3. Enter the following settings for the Numeric Display on the **Settings** page:
 - **Field Size:** 4
 - **Display Value Output:** Ab\1:1

Note Clicking the Display Value Output box displays the Address Reference dialog. Type the address in the box, and click OK.

4. Click the **Appearance** page.

5. Enter the following settings for the Numeric Display on the **Appearance** page:

- **Tool Color:** green
- **Font:** eurostyl

6. Click **outside** the Numeric Display property sheet to close it.

7. Create an Indicator tool. This is tool #4. Size and place this tool on the screen as shown in the figure on .

8. Double-click the **Indicator** tool.

The Indicator property sheet appears.

9. Enter the following setting for the Indicator on the **Settings** page:

Lens Output 0: Ab\4:1.1

Note Clicking the Lens Output 0 box displays the Address Reference dialog. Type the address in the box, and click OK.

10. Click the **Appearance** page.

Notice that the Lens Label State 0 page is selected.

11. Select **red** for the **Lens** color.

12. Click the **Lens Label State 1** tab.

13. Select **yellow** for the **Lens** color.

14. Click **outside** the Indicator property sheet to close it.

If you desire, you can place Panel Labels as shown in the figure on . For an example of the Panel Label icon, see *Using the PTM Toolbar on page 80*.

Configuring the Output Tool and Panel Labels

To configure the Push Button and Panel Labels, follow these steps:

1. Create tool #5. This tool is a Push Button. Size and place the tool on the screen as shown in the figure on .

2. Double-click the **Push Button** tool.

The Push Button property sheet appears.

3. Enter the following settings for the Push Button on the **Settings** page:

- **Type:** Maintained Button
- **Switch Input:** Ti\1:3.3

Note Clicking the Switch Input box displays the Address Reference dialog. Type the address in the box, and click OK.

4. Click the **Appearance** page:

5. Enter the following setting for the Indicator on the **Appearance** page:

Tool Color: gray.

Notice that the Lens Label State 0 page is selected.

6. Click **Edit**.

The cursor appears on the lens of the tool.

7. Type the word **Control**.

8. Click the left mouse button to return to the property sheet.

9. Click on the **Lens Label State 1** tab.

10. Click **Edit**.

11. Type the word **Enabled**.

12. Click the left mouse button to return to the property sheet.

13. Click **outside** the Push Button property sheet to close it.

If you desire, you can place the Panel Labels as shown in the PTM panel window on .

Saving the Panel

To save the panel, follow these steps:

1. On the **File** menu, click **Save Panel**.
2. In the **Panel Name** box, leave the name set to the default **Panel1**.
3. Make sure that **Add to Runtime Panel List** is selected.
4. Click **Save**.
5. On the **File** menu, click **Close Module**.

The PTM panel has been configured for this example.

Configuring DTM

Configure DTM to demonstrate the transfer of data between the two drivers.

To configure DTM, follow these steps:

1. Double-click the **Data Transfer Module (DTM)** icon from the Application Browser.
2. Double-click the **Group Setup** icon.

The Group Setup dialog box appears.

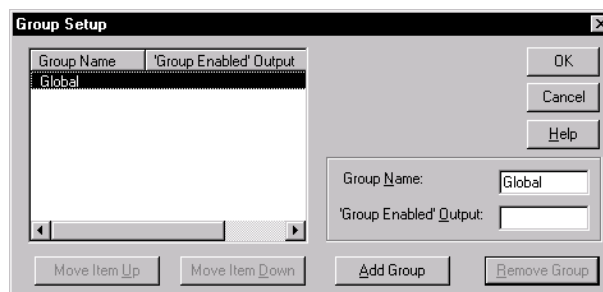

3. Click **Add** **Group**.
4. Type **Control** in the **Group Name** box.
5. Click in the **'Group Enabled' Output** box.

The Address Reference dialog box appears.

6. Type **Ti\1:3.3**; then, click **OK**.
7. Click **OK**.
8. Double-click the **Data Transfers** icon.
9. Double-click on **End Of List**.

The Data Transfer Entry dialog box appears as shown below:

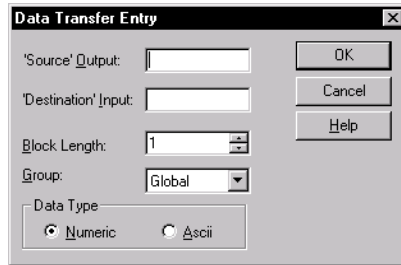

10. Enter the following settings for the data transfer:

- **Source Output:** Ti\timer1
- **Destination Input:** Ab\1:1
- **Group:** Control

Note Clicking the Source Output and Destination Input boxes display the Address Reference dialog. Type the address in the box, and click OK.

11. Click **OK** in the **Data Transfer Entry** dialog box.
12. Double-click on **End Of List**.

The Data Transfer Entry dialog box appears as shown above.

13. Enter the following settings for the data transfer:

- **Source Output:** Ti\1:2.1
- **Destination Input:** Ab\4:1.1
- **Group:** Control

14. Click **OK** on the **Data Transfer Entry** dialog box.
15. Click the **Close** button.

Testing the Example Application

Once you have created and configured an application using the Data Transfer Module (DTM), you are ready to test the modified example application.

Returning to Run Mode

To return to Run Mode, follow these steps:

1. From the **Application Browser**, click the **Application Manager** icon.
2. On the **Run** menu, click **Run Interact**.
3. Click **Yes** to save the application.

The Application Manager Main Menu is displayed.

4. Click on **Run/Prog Mode** to enter Run mode.
5. Click **Go to Module**.

The PTM panel you just created is displayed.

Note DTM does not have a runtime screen. Its purpose is to pass information from one driver to another during Run Mode. DTM does this in the background. The PTM screen you created and are viewing was made for the sole purpose of viewing the transfers. PTM is not necessary when using DTM.

6. DTM was configured to send data from the TI driver to the AB driver. However, transfers will only occur when the 'Control' Output bit is 'true.'

Notice that the timer value in the upper left of the display is changing.

7. Click the **Push Button** in the lower left corner of the display.

The data from these tools is not being sent to the tools tied to the AB driver at this time.

8. Now click the **Control Button** in the center of the panel.

The Indicator changes from red to yellow.

The Control Button is tied to the 'Control' Output bit. Now the data from the Numeric Display on the left is being transferred to the Numeric Display on the right side of the screen.

9. Click the **Push Button** in the lower left corner of the display.

Returning to the Development Environment

To return to the development environment, follow these steps:

1. Press **F10** to return to the Application Manager.
2. Click **Exit Interact**; then, click **Accept**.

The Interact Application Manager window is displayed.

Experiment!

This chapter provides only a brief introduction to the features of DTM. The best way to learn is to experiment.

- Configure additional PTM tools such as a Slide tool tied to a TI reference, and transfer this data to a Horizontal Bar tool tied to an AB reference.

Historical Trending Module

The Historical Trending Module (HTM) gathers selected data from your process or machine control and writes the data to a storage device via “data logging.” This data can be used to tell the use and/or history of the machine or process.

This chapter provides an overview of HTM. An example is provided that shows you how to record and view data that is routed through Interact.

Chapter Contents

<i>Overview of HTM</i>	129
<i>Important Concepts</i>	129
<i>Overview of the Example Application</i>	133
<i>Running the Example Application</i>	133
<i>Modifying the Example Application</i>	142
<i>Testing the Example Application</i>	144
<i>Experiment!</i>	147

Overview of HTM

HTM is an optional software module that runs under the Interact Application Manager (AM). HTM gathers selected data from your process or machine control and writes the data to a mass storage device. This process is called “data logging.” Each data logging event records a snapshot of selected variables to a log file. HTM lets you view this information in several formats to obtain a historical perspective of the process or machine operation.

Important Concepts

The following are important concepts you will need to know as you use HTM.

Log Files

HTM creates log files during run time. Log files consist of records containing data for up to 16 variables. As HTM creates log files, it assigns them sequential numbers (001, 002, etc.) up to a maximum number (referred to as the Maximum File Number). HTM marks each record in the log file with a record number, a time stamp, and a date stamp. It then assigns the following values in the listed format to each record:

Record# Timestamp Datestamp Value1 Value2 Value3...Value16

Log files are defined by a log form. If it is necessary to track more than 16 variables, you can create more than one log form for the process. HTM writes records to the log file each time a Log Trigger occurs. A Log Trigger specifies an event, such as a time interval or data change that triggers HTM to write a record into a data log file.

HTM logs data to a log file until certain criteria are met. Then, a file break occurs. At the time of the file break, the current log file is closed and a new one is opened for continued data logging. A file break can also be based on a time interval or data change.

HTM lets you view the logged information in two different formats: a Chart Display and a Trend Display.

Log Forms

A log form is a template that controls the data logging process. Log forms determine what data variables are logged and how the log files are created and managed. The set of log files associated with a log form is called a data log.

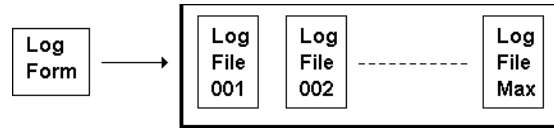

Log forms contain fields that define the following information:

- The location (path name) of the data log
- What variables are written to the log file
- The maximum number of log files associated with the data log
- How and when the information is written to disk

You can create as many log forms as needed for your application.

Data Log

The set of data files associated with a log form is called a data log. When creating a log form, you specify the maximum number of log files the data log may contain. You also specify what happens when the maximum number is reached. There are two options:

- Data logging stops until the operator manually restarts it, or
- Data logging continues, with new log files overwriting the old. This is called “recycling” the data log.

During run time, the operator can start and stop data logging at the Logging Control Display. When logging stops, a data log is said to be inactive. Data can be written only to active data logs.

Log Form List

HTM can manage many data forms and data logs simultaneously. During the configuration of an application, you create a Log Form List to specify which log forms are used and enabled during Run Mode. You must enter the log form on the Log Form List before an application can use it. During Run Mode, the operator can change the enabled/disabled status of any log form.

Write Interval

When HTM logs a data record, it temporarily stores the record in a buffer in memory. Because of the time-consuming nature of disk writes, HTM only writes the records to disk at the interval you specify or when the buffer is full.

File Conversion Utility

HTM comes with a utility that allows you to convert log files to ASCII format so you can use the information with other applications. Select the Convert Log command from the File menu to use this utility.

Note The File Conversion Utility is also available during Run Mode from the Logging Control Display.

Runtime Displays

In Run Mode, the device driver and all Interact modules for the application load and begin running. All data log features are active, and you can begin data logging.

HTM includes a series of displays that are used during runtime to view and control data logging. You can configure the appearance of these screens in the development environment using the Runtime Display command on the Settings Menu. You can also configure the various runtime popup displays, including the Backup popups and the Print History popup.

Trend Display

The Trend Display lets you load a data log and view the data in trend graph form (like a stripchart). This is the first screen that appears when you enter the Run Mode. Initially, the Trend Display is blank since no data has been loaded.

After loading a log file, up to eight variables appear. Each is represented by a pen that draws a trend graph for that variable. On color monitors, you can display each pen in a specific color.

Buttons on the Trend Display let you:

- Initiate a real-time trend update
- Scroll horizontally (in time) through the file showing the date and time stamps under the Trend graph's update
- Move to three other run time displays
- Adjust the Y-axis (vertical) amplitude of the display. This does not affect the data, only how the data appears on the screen.
- Adjust the X-axis (horizontal) time span of the display. Again, this does not affect the data, only how the data appears on the screen.

- Change pen assignments and select the Y-axis scale
- Print the displayed trend graphs. To print other portions of the data log, you must first scroll to that data.
- Perform a search
- Go to next module, previous module, and return to the AM main menu

Above the trend display is the slide cursor button that moves a cursor right and left. Data values under the cursor appear at the left of the screen, in the same color as the pen. The date and time stamps display under the trend data.

At the top of the screen is a message window. The first line of this window displays status messages. If your application includes the Alarm Management Module (AMM), the second line of the window notifies you of alarms.

Chart Display

The Chart Display lets you load a data log and view the data in numeric (chart) form. For each record the following information appears:

- record number
- time and date
- variable values

Buttons to the right of the screen let you scroll up and down through the data. If the record has more than four variables, you also can scroll right and left.

Other buttons on the Chart Display let you do the following:

- Move to three other runtime displays
- Perform a search
- Print the log
- Go to the next module, previous module, and return to the AM main menu

Load Data Log Display

The Load Data Log Display lets you load a data log for view in either the Trend Display or the Chart Display. The Trend Display and the Chart Display are independent, and you can load different data into each.

A selection box follows the cursor as you move it over the list. The variables for the boxed data log appear below the list, and the two-line comment entered in the development environment also displays.

Logging Control Display

The Logging Control Display lists the data logs and lets you perform data log operations during run time.

A selection box follows the cursor as you move it over the list. To highlight a data log, place it in the capture box; then, click with the left mouse button. Now, you can do the following:

- Enable/Disable the data log
- Force a file break which overrides the configured file criteria
- Back up the entire data log or a particular file within the log
- Convert the log data to ASCII text format
- Erase the log from disk
- Create a new data disk

Additional buttons move you to the next module, previous module, and return to the AM main menu.

Overview of the Example Application

The following sections provide hands-on experience using the HTM example application, Htmexamp. Htmexamp contains several existing log forms. In a real application, log forms would be configured to monitor addresses in your controller, but log forms in this example are configured to monitor addresses in the demo driver.

You will explore the example application in several ways:

- A log form, MONITOR1, is configured to automatically begin logging as soon as you enter Run Mode.
- You will load and examine the data log on the Trend and Chart Displays.
- You will edit a log form in the development environment.
- Test the modified example by generating a new data log in Run Mode to see the effects of editing.

Note This example assumes you have the Panel Toolkit Module (PTM) installed on your system and that you are familiar with its operation. If you are unfamiliar with PTM, refer to Chapter 5 of this manual.

Running the Example Application

To run the example, follow these steps:

1. Launch Interact from the MachineShop toolbar.
2. On the **File** menu, click **Open Application**.

A list of available projects appears.

3. Double-click the **APPFILES** folder.

The APPFILES folder opens.

4. Click **Htmexamp**; then click **OK**.

The Application Browser appears with the Htmexamp application loaded.

5. On the **Run** menu, click **Run Interact**.

6. Click **Yes** when you are asked to save changes.

You enter the Interact Run Mode. The HTM Trend Display appears as shown below:

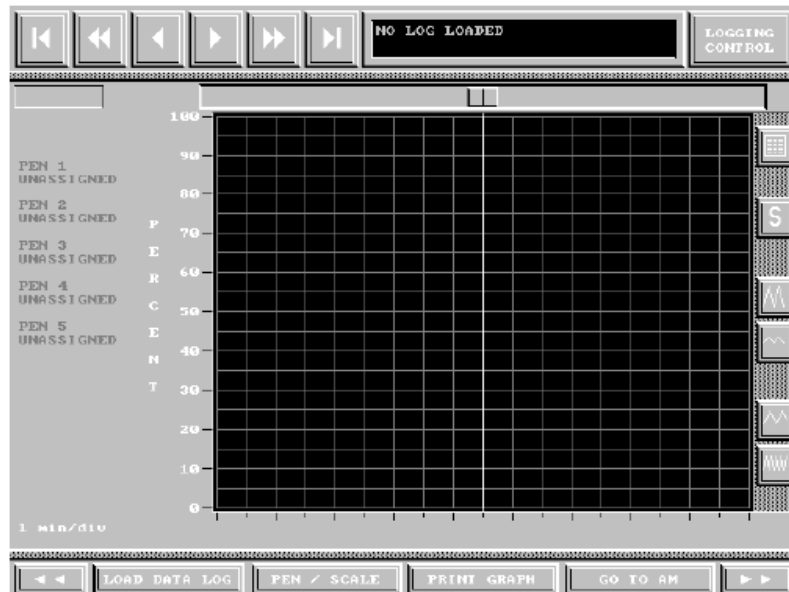

Note This application was configured to go into Run Mode and display the Trend Display when the Run Interact option is selected. Use the Startup Mode parameters configured on the Application Settings property sheet to configure which mode, module, and startup user will be active upon entering Run Mode. As soon as you enter Run Mode, the example will begin logging, so you may notice your hard drive's indicator light blinking.

Loading a Data Log into the Trend Display

First, we will explore the features of the Trend Display by loading and examining a data log.

To load a data log, follow these steps:

1. Click **Load Data Log**.

The Load Data Log display appears.

2. Place the selection box over **MONITOR1**, and click.
3. Click **Accept**.

The data log MONITOR1 is loaded and drawn on the Trend Display. The display will look similar to the one shown below.

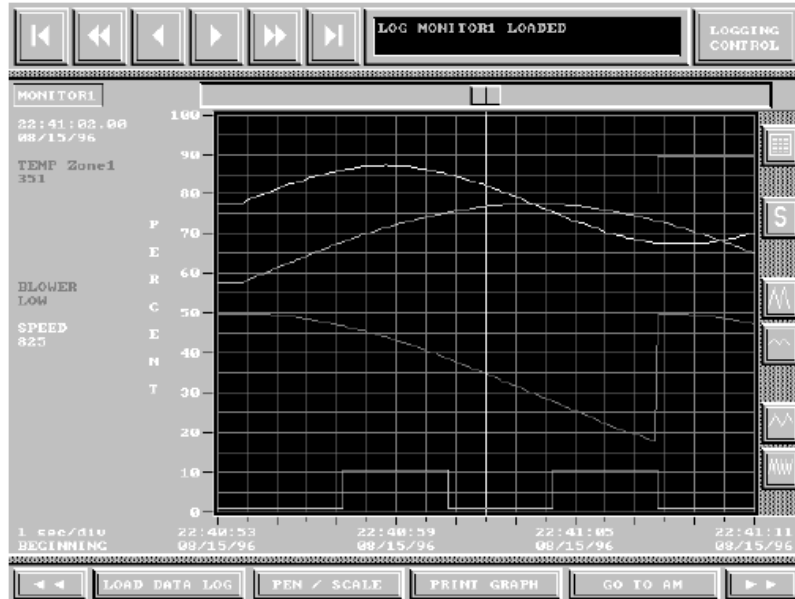

4. Click the **Expand X-Scale** button once, the second button from the bottom along the right edge of the screen.

The graph is redrawn to the new scale. The scale should be set to 10 sec/div.

Moving the Sliding Cursor and Turning Off Pens

Each data field is listed in the column on the left side of the screen. Notice that the value of each data field is listed. Each data field's plot is drawn in the same color as its text.

To move the cursor and turn off pens, follow these steps:

1. Drag the sliding cursor (the gray tab at the top of the Trend Display) to the left or right, and notice how the values change as the cursor moves.

Because there are many values shown, the display is cluttered. You will turn off the plot for the data field "TEMP Zone 2."

2. Click the **Pen\Scale** button.

The Pen Assignments and Y-Axis Scale menu appears as shown below. The pens are listed and identified by the data fields assigned to them. They are all highlighted because they are

currently turned on.

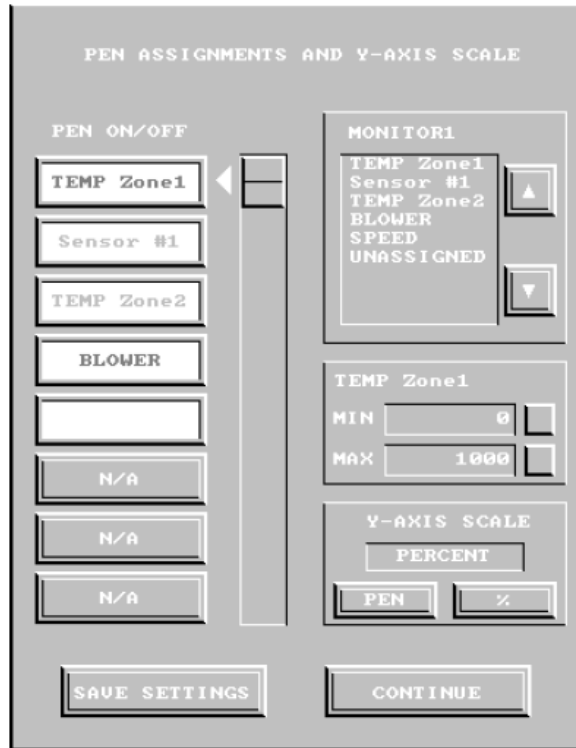

3. Click **TEMP Zone2**.

The highlighting disappears, which means the pen is turned off.

4. Click **Continue**.

If you wanted to permanently change these settings, you could click on Save Settings; then click on Continue. The Trend Display would reappear, and TEMP Zone2 would no longer be displayed.

Adjusting Bias

There is still an overlap between the Speed and Blower data fields, so you will move the Blower plot by adjusting its bias.

To adjust the bias, follow these steps:

1. Click the **Pen/Scale** button.

The Pen Assignment and Y-Axis Scale menu appears.

2. Drag the pen slide selector down to point to **Blower**.

To the right of the cursor is the Y-Axis Scale bias group. The box is labeled Blower. The bias is a discrete pen's Y-axis offset from zero, and the current bias is 80 percent. You will change it to 90, and the plot will move up accordingly on the Y-Scale.

3. Click the square button to the right of the number 80.

A Keypad appears.

4. Type **9, 0**; then click **Enter**.

The Pen Assignments and Y-Axis Scale menu reappears with a new value of 90 set for the blower bias.

5. Click **Continue**.

The Trend Display reappears. Notice that the Blower plot is shifted up to a bias of 90. This appears close to the top of the display.

Changing Y-Scale

The current Y-axis scale is set to percent. Change the Y-axis scale to reflect the units of the TEMP Zone1 plot.

To change the Y-Scale, follow these steps:

1. Click the **Pen/Scale** button.

The Pen Assignment and Y-Axis Scale menu appears.

2. Drag the pen slide selector up to point to TEMP Zone1.
3. Click **Pen** in the **Y-Axis Scale** group.

“TEMP Zone1” appears in the window.

4. Click **Continue**.

The Trend Display reappears. Notice that the Y-axis coordinates now correspond to TEMP Zone1.

Loading a Data Log into the Chart Display

In this part of the example, you will explore the Chart Display by loading and examining a data log.

To load a data log, follow these steps:

1. From the **Trend Display**, click the **Chart Display** button located at the top right edge of the screen (the tablet icon).

A blank Chart Display appears because of the lack of data.



2. Click the **Load Data Log** button.

The Load Data Log Display appears.

3. Place the selection box over **MONITOR1** and click.
4. Click **Accept**.

The data log MONITOR1 is loaded and appears on the Chart Display as shown below:

10:48:09		MONITOR1.003					
RECORD	DATE	TIME	TEMP Zone1	Sensor #1	TEMP Zone2	BLOWER	
1	01 JUL 96	09:45:47	409	CoolantOff	375	LOW	
2	01 JUL 96	09:45:48	407	CoolantOff	376	LOW	
3	01 JUL 96	09:45:48	406	CoolantOff	376	LOW	
4	01 JUL 96	09:45:48	405	CoolantOff	376	LOW	
5	01 JUL 96	09:45:48	404	CoolantOff	377	LOW	
6	01 JUL 96	09:45:48	402	CoolantOff	378	LOW	
7	01 JUL 96	09:45:48	401	CoolantOff	378	LOW	
8	01 JUL 96	09:45:48	479	CoolantOff	379	LOW	
9	01 JUL 96	09:45:48	478	CoolantOff	380	LOW	
10	01 JUL 96	09:45:48	476	CoolantOff	380	LOW	
11	01 JUL 96	09:45:49	474	CoolantOff	381	LOW	
12	01 JUL 96	09:45:49	473	CoolantOff	382	LOW	
13	01 JUL 96	09:45:49	471	CoolantOff	383	LOW	
14	01 JUL 96	09:45:49	469	CoolantOn	384	LOW	
15	01 JUL 96	09:45:49	467	CoolantOn	385	LOW	
16	01 JUL 96	09:45:49	465	CoolantOn	387	LOW	
17	01 JUL 96	09:45:49	463	CoolantOn	388	LOW	
18	01 JUL 96	09:45:49	461	CoolantOn	389	LOW	
19	01 JUL 96	09:45:49	459	CoolantOn	390	LOW	
20	01 JUL 96	09:45:50	457	CoolantOn	392	LOW	
21	01 JUL 96	09:45:50	455	CoolantOn	393	LOW	
22	01 JUL 96	09:45:50	453	CoolantOn	395	LOW	
23	01 JUL 96	09:45:50	450	CoolantOn	396	LOW	

Examining the Data Log

The records of the data log are displayed in a tabular format. The date and time of each record is listed on the left side of the vertical dotted line, and the data fields are listed on the right. The arrow at the far right side of the column headings indicates there are more data fields to the right.

To examine the data log, follow these steps:

1. Click the **right arrow** button, located on the right edge of the screen, to scroll right by one data field.

Notice the data fields scroll, but the record number, date, and time remain in place.

2. Click the **left arrow** button, located on the right edge of the screen, to scroll left by one data field.
3. Click the **down arrow** button, located on the right edge of the screen, to page down through the records.

Searching for a Data Value

A powerful feature of HTM is its ability to search a data log for specific times or data values. In this series of steps, you will search for a value in the TEMP Zone2 column.

To search for a data value, follow these steps:

1. A search begins from the current position in the data log. Click the **Beginning of Data Log** button, which is the second button from the bottom on the right edge of the display.

You move back to the very beginning of the data log. Notice the top record is record number 1. The search will start with the top record (record number 1) and end when a match is found or the end of the data log is reached.

2. Click the **S** button located on the right edge of the display.

The Search menu appears as shown below. The Data Search button is selected, indicating this is the Data Search menu.

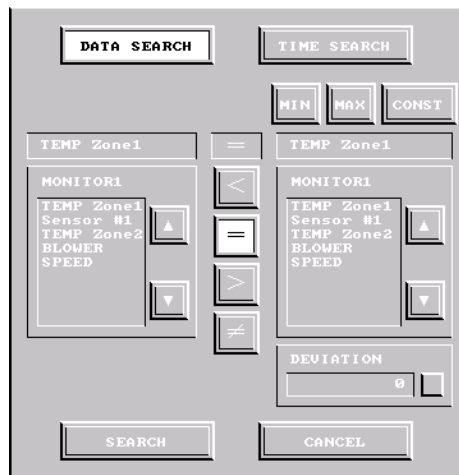

3. Click **TEMP Zone2** in the left selection box.

It appears in the window at the top of the selection box. The equal sign (=) already appears as the current comparison operator.

4. Click the **CONST** button (Numeric Constant).

A keypad appears.

5. Type **4, 0, 0**; then click **Enter**.

The Data Search menu appears with the TEMP Zone2 parameter equal to 400.

Now you will add a small deviation factor to the numeric constant. Maybe the data field never had a value of exactly 400, but you still want to know if it was within a certain range.

6. Click the gray button in the **Deviation** area.

A keypad appears.

7. Click **3**; then click **Enter**.

A deviation of 3 is entered in the Deviation area. This means that the search will consider any value between 397 and 403 (inclusive) to be a match.

8. Click the **Search** button.

You return to the Chart Display while the searching starts.

When the first occurrence of TEMP Zone2=400 +/-3 is located, the record is displayed at the top of the list, and Search Successful appears in the Message Window.

To search for the next occurrence, follow these steps:

1. Click the **S** button.

The Search menu appears, and the search string of TEMP Zone2=400 is displayed.

2. Click the **Search** button.

The search will begin at the current position in the data log, and stop at the next match.

Modifying the Example Application

In this part of the example, you will enter the development environment and add a data field to the log form MONITOR1. Then you will go back to Run Mode and see the new data field plotted on the Trend Display.

Returning to the Development Environment

To return to the development environment, follow these steps:

1. Press **F10** to return to the Application Manager Main Menu.
2. Click **Exit Interact**; then click **Accept**.

The Interact Application Manager window is displayed.

Loading the Log Form

To load a log form, follow these steps:

1. Double-click the **Historical Trending Module (HTM)** icon.
2. Double-click the **Log Forms** icon.
3. Double-click the **MONITOR1** icon.

The Record Data Fields window is displayed as shown below:

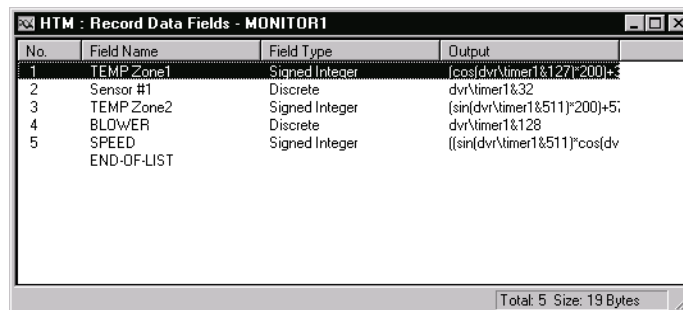

No.	Field Name	Field Type	Output
1	TEMP_Zone1	Signed Integer	(cos[dvr\Timer1&127]*200)+5
2	Sensor #1	Discrete	dvr\Timer1&32
3	TEMP_Zone2	Signed Integer	(sin[dvr\Timer1&511]*200)+5;
4	BLOWER	Discrete	dvr\Timer1&128
5	SPEED	Signed Integer	((sin[dvr\Timer1&511]*cos(dv
	END-OF-LIST		

Adding a Data Field

To add a data field, follow these steps:

1. Double-click on **End-of-List**.
2. On the **Edit** menu, click **Insert Field**.

The Field Definition dialog box appears as shown below:

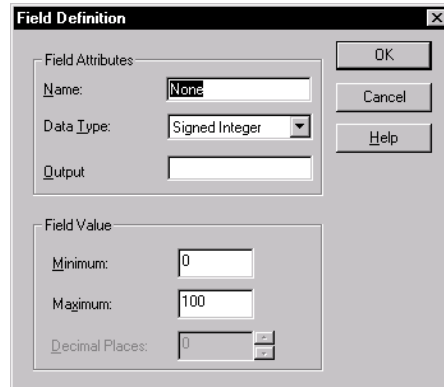

3. Type **Fan** in the **Name** box.
4. Click on **Discrete** in the **Data Type** box.
5. Click the **Output** box.

The Address Reference dialog box appears.

6. Type **dvr\timer1&64**.
7. Click **OK**
8. Enter **60** in the **Graph Bias** box; then click **OK**.

The Record Data Fields window now reflects your addition at Data Field number 6.

Adding a Log Form Comment

To add a log comment, follow these steps:

1. On the **File** menu, click **Log Form Properties**.

The Log Form Properties property sheet appears.

2. Click the **Comments** page.

The Comments page appears.

3. Type **Added data field FAN** in the Comment Line 1 box.
4. Click **OK**.

The Record Data Fields window is active.

5. Close the **Record Data Fields Close** window.

6. Click **Yes** to save changes to the MONITOR1.HTM form.

Testing the Example Application

Now that you have modified the example application using the Historical Trending Module (HTM), you are ready to test the application.

Returning to Run Mode

To return to Run Mode, follow these steps:

1. From the **Application Browser** click the **Application Manager** icon.
2. On the **Run** menu, click **Run Interact**.
3. Click **Yes** when you are asked to save changes.

The Trend Display appears.

4. Click on **Logging Control**.

The Logging Control Display appears. Notice that the status message (in red) for MONITOR1 reports that the log format changed.

Erasing Old Log Files

Since you added a data field to the log form, the previously logged records are incompatible with the new log form. All the old log files must be deleted, and logging must begin in the new format.

To erase old log files, follow these steps:

1. From the **Logging Control** display, select **MONITOR1** by placing the selection box over it and clicking.
2. Click **Erase Log**.

A menu appears which allows you to continue with or cancel the erase.

3. Click **Continue**.

The data log is empty, meaning all the old log files have been deleted.

4. Click **Data Log Enable/Disable** located in the upper left corner of the display.

This re-enables the data log MONITOR1, and logging begins immediately.

5. Click **Leave Log Ctrl**.

The Trend Display appears.

Loading the Data Log

To load the new data log, follow these steps:

1. Click **Load Data Log**.

The Load Data Log Display appears.

2. Select **MONITOR1** by placing the selection box over it and clicking.

Notice the log form comment that you added is displayed at the bottom of the screen.

3. Click **Accept**.

The data log MONITOR1 is loaded and drawn on the Trend Display.

Adjusting the X-Scale and the Pen Assignment

Adjust the X-Scale so that the display is easier to read.

To adjust the X-scale and the pen assignment, follow these steps:

1. Click once on the **Expand X-Scale** button, this is the second button from the bottom along the right edge of the screen.

The graph is redrawn at the new scale. The graph still appears much as it did before you added the new data field. You will not see a plot for the new data field until you assign it to one of the pens.

2. Click the **Pen/Scale** button.

The Pen Assignment and Y-Axis Scale menu appears.

3. Drag the pen slide selector down to point to the third pen, **TEMP Zone2**.

4. Click **FAN** in the list of data fields to the right.

FAN, the data field we added in the development environment, is now assigned to the third pen.

5. Click the fifth pen, **Speed**, to toggle this pen off.

This will make it easier to view the plot of your new data field.

6. Click **Continue**.

The Trend Display reappears. Four data field plots are shown, and the second one from the top is FAN.

7. Click **Go To AM**, located at the bottom right of the screen, to return to the Application Manager Main Menu.

8. Click **Exit Interact**; then click **Accept** to return to the development environment.

Experiment!

This chapter provides only a brief introduction to the features of HTM. The best way to learn is to experiment.

- Load one of the example log forms in the development environment. Add a data field, and change the configuration of the Trend Display to allow more pens to be assigned. Load the edited log form in Run mode, and observe the results.
- Back up a data log from the Logging Control screen.
- Search for data and time values in a data log from the Trend Display or the Chart Display.

Recipe Control Module

The Recipe Control Module (RCM) helps you create a library of recipes containing process values. You can load, modify, and store these recipes online as called for by your production process. RCM automatically produces a recipe activity log for each recipe. The logs are stored in ASCII comma delimited format for ease of review.

This chapter provides an overview of RCM. The included example will show you how to create a recipe, load it into memory, and send it to a controller.

Chapter Contents

<u>Overview of RCM</u>	<u>149</u>
<u>Important Concepts</u>	<u>149</u>
<u>Overview of the Example Application</u>	<u>152</u>
<u>Running the Example Application</u>	<u>152</u>
<u>Modifying the Example Application</u>	<u>156</u>
<u>Testing the Example Application</u>	<u>159</u>
<u>Experiment!</u>	<u>162</u>

Overview of RCM

RCM is an optional software program that runs under the control of the Interact Application Manager (AM). RCM allows you to create and modify recipes, load recipes into memory, download recipes to a controller, and save recipes to disk. You can also configure recipes to be sent automatically using “triggers” such as an event or the time of day.

When you configure a recipe, you enter (preset) the values that will be downloaded to the controller. During Run Mode, operators with the proper user level can modify the preset values before download to adjust to current manufacturing conditions. If maximum and minimum values were assigned during configuration, edited preset values are checked to ensure they remain between these limits. An example of a recipe appears below:

Recipe Name: Plastech			
Variable Name	Variable Type	Controller Address	Value
RESIN1	Analog	DVR\4:102	220.00
RESIN2	Analog	DVR\4:104	320.00
COLOR RED	Discrete	DVR\4:106	1

When the recipe Plastech is downloaded to the controller the following events occur:

- The analog value 220 is written to address DVR\4:102 (RESIN 1)
- The analog value 320 is written to address DVR\4:104 (RESIN 2)
- The discrete value 1 is written to address DVR\4:106 (COLOR RED)

Important Concepts

The following are important concepts you will need to know as you use RCM.

Scaling the Downloaded Values

RCM includes a feature which allows analog data values to be “scaled” by a given percentage before downloading. This feature, known as “percent scaling” adjusts every analog value in the recipe for which scaling was configured.

Uploading Values from the Controller

Another unique feature of RCM allows variables to be read from the controller and saved in a recipe for future downloading. Reading values from the controller is called “uploading.”

User Levels

During configuration, most components on the Recipe Display and the Edit Recipe Display can be assigned a user level to restrict access to that function. Interact supports six user levels numbered from 0 to 5. User level 0 is the highest user level, offering the most privileges; user level 5 is the lowest user level, offering the least privileges.

You may decide to restrict operators from some or all of the functions critical to the operation of RCM. To restrict operators from using a function, you must assign each operator a user name. You must then assign a user level to the user name that defines the operations available to each operator.

For more security, you can assign each user level a unique alphanumeric password in the Application Manager. Passwords must be between 1 and 15 characters long.

Key Assignments

The Recipe Display is used by the operator during Run Mode. Recipe Display components can be assigned keyboard keys that the operator can press to move directly to the component and perform the assigned operation. For example, pressing F2 might perform the same operation as clicking the Percent Scale button with the left mouse button. The default key assignments for the Recipe Display components are listed below.

Note During configuration of the Recipe Display, you can change the key assignments to any key on the keyboard.

Component	Default Key Assignment
Send Recipe to Controller button	F1
Percent Scale button	F2
Recipe Message Window	F3
Edit Recipe button	F4
Recipe Activity button	F5
Scroll Up button	CTRL- PAGE UP
Scroll Down button	CTRL-PAGE DOWN
Page Up button	PAGE UP
Page Down button	PAGE DOWN
Beginning of File button	HOME
End of File button	END
Load Recipe button	F6

Save Recipe button	F7
Backup Log button	F7
Delete Recipe button	F8
Print Log button	F8
Go To Module button	F9
Previous Module button	Not Assigned
Next Module button	Not Assigned

The function keys F1 through F10 can be used together with the Shift, Ctrl and Alt keys to provide 40 function keys, listed below:

Pressing these keys	Assigns these functions
F1 through F10	F1 through F10
Shift+ F1 through F10	F11 through F20
Ctrl+ F1 through F10	F21 through F30
Alt+ F1 through F10	F31 through F40

Run Mode

You can perform the following operations using the RCM Run Mode:

- Download recipes to a controller, either manually by an operator or automatically triggered by a controller event or the time of day
- Upload values to be used in a recipe from a controller
- Load and save recipes
- Edit recipes online
- Scale recipe data before downloading
- Log recipe activity to a file

Overview of the Example Application

The following sections provide hands-on experience with actual Recipe Module recipes. This example consists of an application, Rcmexamp, which contains several recipes and a panel created in PTM. You will explore the example application in several ways:

- Load and view a recipe on the RCM Run Mode Recipe display and send the recipe to the demo “controller”
- View a related PTM panel which displays current recipe information
- Edit the recipe
- Test the modified example

Note This example assumes you have the Panel Toolkit Module (PTM) installed on your system and that you are familiar with its operation. If you are unfamiliar with PTM, refer to Chapter 5 of this manual.

Running the Example Application

To run the example, follow these steps:

1. Launch Interact from the MachineShop toolbar.
2. On the **File** menu, click **Open Application**.

A list of available projects appears.

3. Double-click the **APPFILES** folder.

The APPFILES folder opens.

4. Click **Rcmexamp**; then, click **OK**.

The Application Browser appears with the Rcmexamp application loaded.

5. On the **Run** menu, click **Run Interact**.
6. Click **Yes** when you are asked to save changes.

You enter the Interact Run Mode. The PTM panel used with this example is displayed.

Note This application was configured to go into Run Mode when the Run Interact option is selected. Use the Startup Mode parameters configured on the Application Settings property sheet to configure which mode, module, and startup user will be active upon entering Run Mode. For this application the PTM panel used with this example is the first Run Mode screen displayed.

Loading a Recipe

To load a recipe, follow these steps:

1. Click on the **Go To Recipe Module** button.

The Recipe Display appears.

2. Click on the **Load Recipe** button located in the lower left corner of the display.

A list of recipes is displayed.

3. Move the selection bar over recipe Durogoop, and click to select the recipe.

Durogoop is now shown as the Selected Recipe in the Recipe Load Message Window.

4. Click on the **Accept** button located in the upper right corner of the Recipe Display.

The Durogoop recipe is displayed on the RCM Recipe Display as shown below.



The recipe items are listed on the screen along with their current values.

Sending the Recipe to the Controller and Viewing the Panel

In a real application, you will see the effect of downloading a recipe to the controller in your actual process. For this example, you can see the effect of downloading a recipe to the demo driver on a PTM panel.

To download the recipe and view the result, follow these steps:

1. Click the **Send Recipe To Controller** button located in the upper left corner of the Recipe Display.

The recipe is downloaded to the demo driver. A message appears in the Recipe Message Window indicating the recipe has been sent.

2. Click the **left arrow** button located in the lower-left corner of the display.

The PTM panel used with this example is displayed as shown below:



The bottom half of the example panel contains PTM tools which display current recipe values in the controller and perform other PTM operations. The name of the current recipe, Durogoop, is displayed on the **Indicator** tool in the lower left of the screen.

Note The top half of the example panel contains tools used to demonstrate Remote Recipe features.

Editing the Recipe

From the **RCM Recipe Display**, editing of recipe data values can be performed.

To edit data in the recipe, follow these steps:

1. From the PTM example panel, click **Go To Recipe Module**.

The RCM Recipe Display appears.

2. Click the **Edit Recipe** button found in the upper right corner of the display.

3. Click the value **220.000** for the item **Resin 1**.

4. A Numeric Entry Keypad appears.

Click **5, 0**; then, click **Enter**.

Resin 1 now has a value of 50.

5. Click the **Save Recipe** button located at the bottom of the screen.

The Recipe Save Message Window displays Durogoop as the selected recipe.

6. Click the **Accept** button found in the upper right corner of the display.

7. Click the next **Accept** button.

8. Click **Leave Edit** located in the upper right corner of the display.

The RCM Recipe Display appears, and the new value is reflected. Now download the recipe, and view the result of your edits:

9. Click **Send Recipe To Controller**.

10. Click the **left arrow** button in the lower-left corner of the display.

The example PTM panel appears. Notice that the new value of 50 for Resin 1 is displayed.

Exploring the RCM Remote Recipe Features

In this section you will explore the Rcmexamp application using Remote Recipe features. A recipe will be viewed on a PTM Remote Message display. The recipe will then be edited, and you will observe the changes.

To load a recipe from the Remote Message Display, follow these steps:

1. Click the **Load Recipe** button located within the Remote Recipe Control.

A list of available recipes are displayed.

2. Click **OK**.

The Durogoop recipe is displayed in the **Remote Recipe Control** window as shown below:



Recipe items are listed on the screen, along with their current values.

Sending the Recipe to the Controller and Viewing the Panel

In a real application, you will see the effect of downloading a recipe to the controller in your actual process. For this example, you can see the effect of downloading a recipe to the demo driver on a PTM panel.

To download the RCM recipe and view the result, follow these steps:

1. Click the **Send Recipe** button located in the Remote Recipe Control.

The recipe is downloaded to the demo driver. A message appears in the Remote Recipe Control indicating the recipe has been sent.

2. The name of the current recipe, Durogoop, is displayed on the **Indicator** tool in the lower left corner of the panel.

Modifying the Example Application

In this exercise, you will learn to perform the following tasks:

- Create a simple recipe named Paste consisting of two ingredients, Flour and Water
- Download the recipe to the demo driver and view the results of downloading on the example panel

Returning to the Development Environment

To return to the development environment, follow these steps:

1. From the PTM panel, click **Go To AM** to return to the **Application Manager Main Menu**.
2. Click **Exit Interact**; then, click **Accept**.

The Interact Application Manager window is displayed.

Creating the Recipe

To create the recipe, follow these steps:

1. Double-click on the **Recipe Module (RCM)** icon.
2. Double-click on the **Recipes** icon.
3. Double-click on the **New Recipe** icon.

The Recipe Item Definitions window appears as shown below:

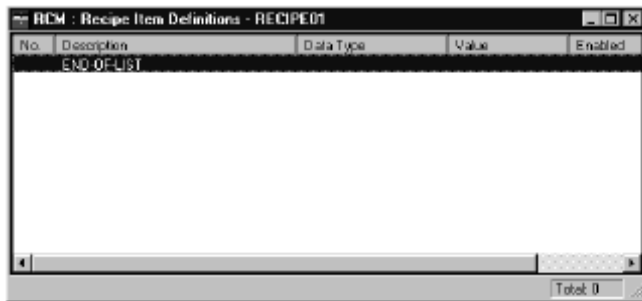

4. Click the **Insert Item** icon on the toolbar, or double-click **End of List**.

The Recipe Item Definition dialog box appears as shown below:

5. Type **Resin1 - Flour** in the Description box.

This is the description of our first recipe item.

6. Click the **Send Value Input** box.

The Address Reference dialog box appears.

7. Type **DVR\4:101**; then, click **OK**.

This is the address referencing the first recipe item. Notice that the address you entered now appears in the Send Value Input box.

8. Click the **Analog Value** box, and enter **100**.

9. Click **OK**.

The completed recipe is displayed in the Recipe Item Definitions window.

Now create the second recipe entry.

1. Click the **Insert Item** icon.

The Recipe Item Definition dialog box appears.

2. Click the **Description** box, and type **Resin 2 - water**.

This is the description of the second recipe item.

3. Click the **Send Value Input** box.

The Address Reference dialog box appears.

4. Type **DVR\4:102**; then, click **OK**.

This is the address referencing the second recipe item. Notice that the address you entered now appears in the Send Value Input box.

5. Click the **Analog Value** box, and enter **15**.

6. Click **OK**.

The completed entry is displayed in the Recipe Item Definitions window.

7. To change the order of the recipe items, press the **Move Item Up** or **Move Item Down** icons on the toolbar.

Creating a Recipe Comment

Before saving the recipe, you will add a Recipe Comment that is displayed on the Run Mode

screen when the recipe is loaded.

To make a recipe comment, follow these steps:

1. On the **File** menu, click **Recipe Properties**.

The Recipe Properties property sheet appears as shown below:

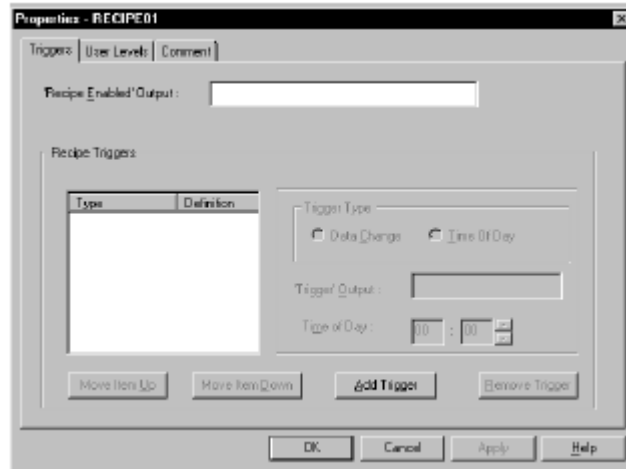

2. Select the **Comment** page.
3. Type the following message:

```
This is a recipe for paste.  
Resin 1 = FLOUR  
Resin 2 = WATER
```

4. Click **OK**.

The Recipe Item Definitions window appears.

5. Close the Recipe Item Definitions window.

6. Select **Yes**.

The Save As dialog appears.

7. Type **Paste** in the File Name box; then, click **OK**.

Testing the Example Application

Now that you have used the Recipe Control Module (RCM) and created a recipe, you are ready to test the application.

Returning to Run Mode

To return to Run Mode, follow these steps:

1. From the **Application Browser**, click the **Application Manager** icon.
2. On the **Run** menu, click **Run Interact**.
3. Click **Yes** when you are asked to save changes.

The PTM panel used in this example appears.

4. Select the **Go To Recipe Module** button.

The Recipe Display appears.

Sending the Recipe to the Controller and Viewing the Panel

To load the new recipe and download to the controller, follow these steps:

1. Click the **Load Recipe** button located at the bottom left of the display.

A list of recipes is displayed.

2. Click on **Paste**.

Paste is now shown as the Selected Recipe in the Recipe Load Message window.

3. Click **Accept**.

The Paste recipe is displayed on the RCM Recipe Display.

4. Click **Send Recipe to Controller**.

5. Click on the **left arrow** button located at the bottom-left of the display.

The example PTM panel appears. The values you entered are Resin 1 (flour) and Resin 2 (water), 100 and 15 respectively, are displayed. These are the only items our new recipe has in common with the example panel.

Disregard the values of Resin 2X, Resin 3, and Secret X. You did not make entries for them in the Paste recipe.

The PTM button label No Recipe Loaded is displayed because you did not modify the PTM panel to operate with the Paste recipe. Refer to your PTM help file for information about editing PTM panels.

6. Click on **Go To AM** to return to the **Application Manager Main Menu**.

7. Click **Exit Interact** followed by **Accept** to return to the development environment.

Experiment!

This chapter provides only a brief introduction to the features of RCM. The best way to learn is to experiment.

- Try the percent scaling feature with the Durogoop recipe. Change the scale to 50%, send the recipe to the controller, and view the scaled recipe values on the example panel.
- Load the other recipes in the example application, and view them on the example panel.
- Experiment with disabling/enabling a recipe item from the edit screen.
- Press Recipe Activity on the Run Mode screen to view the recipe log file. Recipe logging must be enabled in the development environment for any recipe activity to be displayed.
- Edit both Paste recipe entries so the Minimum and Maximum values are 0 and 500, respectively, and Percent Scaling is enabled. Enter Run Mode, and experiment with changing the scale.

Machine Configuration Module

The Machine Configuration Module (MCM) helps you create a library of groups and lists containing process values that perform manufacturing product “changeovers.” You can load, modify, and store these groups online as called for by your production process. MCM can produce an activity log for each group or list. The logs are stored in ASCII comma delimited format for ease of review.

This chapter provides an overview of MCM. It also provides you with an example to show you how to create a group or list, load it into memory, and send it to a controller.

Chapter Contents

<i>Overview of MCM</i>	164
<i>Overview of the Example Application</i>	170
<i>Running the Example Application</i>	170
<i>Modifying the Example Application</i>	183
<i>Testing the Example Application</i>	188
<i>Experiment!</i>	189

Overview of MCM

MCM is an optional software program that runs under the control of the Interact Application Manager (AM). MCM allows you to create and modify groups and lists, load them into memory, download them to a controller, and save them to disk. You can also configure groups and lists to download automatically using “triggers” including events and time of day.

When you configure a group or list, you enter (preset) the values that will download to the controller. During Run Mode, operators with the proper user level can modify the preset values before download to adjust to current manufacturing conditions. If maximum and minimum values were assigned during configuration, edited preset values are checked to ensure they remain between these limits. An example of a list appears below:

List Name: TMBODIES			
Item Name	Item Type	Controller Address	Value
Melt Time	Analog	DVR\3:1	90
Shot Size	Analog	DVR\3:2	300
Injection Time	Analog	DVR\3:3	20
Cool Time	Analog	DVR\3:4	40
Vat Open	Discrete	DVR\3:10.1	1 (on)
Door Closed	Discrete	DVR\3:10.2	0 (off)
Screw Heat On	Discrete	DVR\3:10.3	1 (on)
Screw Engaged	Discrete	DVR\3:10.4	1 (engaged)

When you download the list TMBODIES to the controller, the following events occur:

- MCM writes the analog value 90 to address DVR\3:1 (Melt Time).
- MCM writes the analog value 300 to address DVR\3:2 (Shot Size).
- MCM writes the analog value 20 to address DVR\3:3 (Injection Time).
- MCM writes the analog value 40 to address DVR\3:4 (Cool Time).
- MCM writes the discrete value 1 to address DVR\3:10.1 (Vat Open).
- MCM writes the discrete value 0 to address DVR\3:10.2 (Door Closed).
- MCM writes the discrete value 1 to address DVR\3:10.3 (Screw Heat On).
- MCM writes the discrete value 1 to address DVR\3:10.4 (Screw Engaged).

Important Concepts

The following are important concepts you will need to know as you use MCM.

Groups and Active Lists

MCM's structure allows you to cluster lists into groups, adding a level of hierarchy to the MCM structure. You can add, name, delete, change, and assign user levels to groups, the same way you can with lists. They allow you to organize your lists into categories. You can also block certain users from accessing certain groups.

When you download a list, it becomes the active list from its particular group. MCM tracks which list is currently active in each group. You can have more than one list active at one time, but they must be in separate groups. You can only have one active list per group.

You can view the groups and lists we have configured for the MCM example application. This will help you see how we have organized our lists.

To view the groups, follow these steps:

1. Launch Interact from MachineShop toolbar.
2. On the **File** menu, click **Open Application**.

A list of available projects appears.

3. Double-click the **APPFILES** folder.

The APPFILES folder opens.

4. Click **Mcmexamp**; then, click **OK**.

The Application Browser appears with the Mcmexamp application loaded.

5. Double-click the **Machine Configuration Module (MCM)** icon in the Application Browser.
6. Double-click the **Groups** icon.

You can see the four groups we have configured for the example application. You will open two of these to see how we have set up the application.

Double-click the **MACHCONF** group to show its

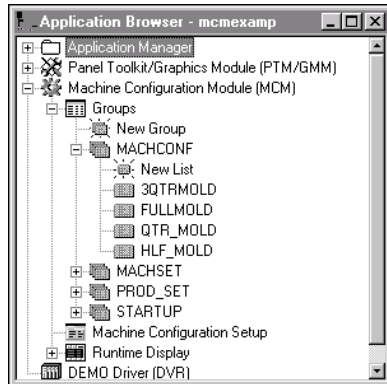

lists.

As you can see, the MACHCONF group contains four lists. By opening the groups, you can see the basic structure of this application. When you enter Run Time, you will open and manipulate these groups and lists.

Verifying Items after Downloads

When you enable this option for certain list items and include a verify event list item, MCM will read back these items after it has downloaded the list items to the controller. If it finds any discrepancies between the value in the list and the value in the controller, it will notify the operator. (You must enable verify for each specific item you want verified, **and** add a verify event for MCM to read those items back.)

Monitoring Values in the Controller

Another unique feature of MCM allows it to read each list item continuously after it downloads the list to the controller. You can configure Interact to display the value it reads next to the list's current value, or Interact can automatically update the list's current value. A changed value will appear in a different color in the Remote List Display tool, allowing the operator to upload and save the new value if they so desire.

Hot-Editing the Downloaded Values

With this option enabled, you can edit a list item in a group's "active list." MCM will immediately send the new value to the controller. You do not have to re-send the entire list to update the value.

Structuring Hierarchies within Lists

MCM is structured so that you can place each list into a category called a group. You saw this earlier in the chapter. You determine the number of groups, their names, and their security levels. This allows you to give only authorized personnel access to certain lists. For example, you could restrict access so that only field service personnel would have access to "Machine Setup" lists.

You can also configure lists to download other lists from different groups. In this way, you can nest lists within lists and use an initial list to trigger the secondary one(s). An example of this "list of lists" is our startup list.

To view the Startup List, follow these steps:

1. Double-click the **Startup** group icon.
2. Double-click **Start01**.

This opens the list named Startup. Notice that the Data Type column tells you that each item is a list. The Value column gives you the names of each list this list downloads.

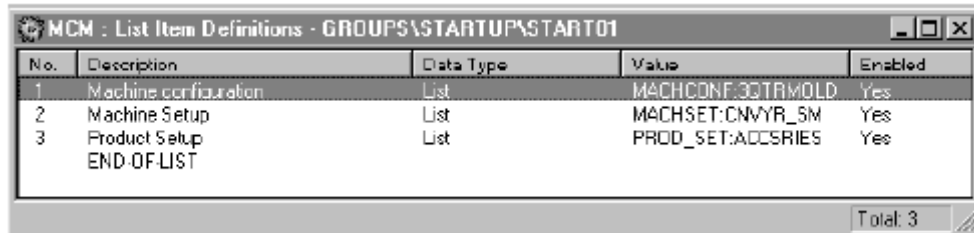

No.	Description	Data Type	Value	Enabled
1	Machine configuration	List	MACHCONF:3STRMOLD	Yes
2	Machine Setup	List	MACHSET:CNVYR_SM	Yes
3	Product Setup	List	PROD_SET:ACCSRIES	Yes
	END-OF-LIST			

We configured MCM to automatically download this list to the controller when you enter Run Mode.

Single-button Downloads

MCM also includes a new feature allowing a single button to both load a list and send it to the controller in a single click. You can assign this function to a push button using a new MCM address reference for this purpose.

Key Assignments

The operator can use the Activity Log Display during Run Mode to view MCM activity events. You can assign display components to keyboard keys that the operator can press to move directly to the component and perform the assigned operation. For example, pressing F10 performs the same operation as clicking the Go to AM button with the left mouse button. The default key assignments for the Activity Log Display components are listed below.

Note When you configure the Activity Log Display, you can change the key assignments of certain commands to any key on the keyboard.

Component	Default Key Assignment
Scroll Up button	CTRL- PAGE UP
Scroll Down button	CTRL-PAGE DOWN
Page Up button	PAGE UP
Page Down button	PAGE DOWN
Start of Log button	HOME
End of Log button	END
Backup Log button	F7
Print Log button	F8
Previous Module button	none
Next Module button	none

You can use the function keys F1 through F10 together with the Shift, Ctrl and Alt keys to provide 40 function keys, listed below:

Pressing these keys	Assigns these functions
F1 through F10	F1 through F10
Shift+ F1 through F10	F11 through F20

Ctrl+ F1 through F10 F21 through F30

Alt+ F1 through F10 F31 through F40

Run Mode

Using MCM in Run Mode you can:

- Download lists to a controller, either manually by an operator or automatically triggered by a controller event or the time of day.
- Monitor item values in the controller for changes and update their lists when changes occur.
- Verify list items after downloading them to the controller to make sure the values are correct.
- Load and send a list with a single click on a push-button.
- Upload values to be used in a list from a controller.
- Load and save lists.
- Edit lists online.
- Log list activity to a file.

Overview of the Example Application

The following sections provide hands-on experience with actual Machine Configuration Module lists. This chapter will walk you through our example application, Mcmexamp. This application contains four groups, each containing pre-configured lists. We have also created three panels in PTM/GMM to show you how to set up an interface with MCM. In the example application you will:

- Load and view a list from a PTM/GMM panel and send the list to the virtual controller.
- Edit the list, watching how “hot edit,” “monitor,” and “monitor with update” affect the editing process.
- Test the modified example.
- Upload the new values into your active list.
- Save and delete new lists.
- Test the single-button download feature.

Note This example assumes you have the Panel Toolkit Module (PTM) and the Graphics Monitoring Module (GMM) installed on your system and that you are familiar with its operation. If you are unfamiliar with PTM, refer to Chapter 5 of this manual.

Running the Example Application

To run the example, follow these steps:

1. From the **Application Browser**, click the **Application Manager** icon.
2. On the **Run** menu, click **Run Interact**.
3. Click **Yes** if you are asked to save changes.

You will enter the Interact Run Mode, briefly pausing in the Application Manager while Interact loads the application.

Note We configured this application to go directly into Run Mode when you run Interact. The Start-up mode parameters configured on the Application Settings property sheet define which mode, module, and start-up user will be active upon entering Run Mode. We also configured the application to immediately download the “startup” list, which contains one list from each group. You will learn more about this in

Modifying the Startup Se

In the Remote List Display tool at the top of this first PTM panel, you will see the groups you looked at earlier in the Windows Application Manager. Clicking a group name will show the lists contained in that group. Clicking a list name will load it so you can view its items in the Remote List Display tool. The buttons on the right side of the tool allow you to move your highlight bar up and down a list or group. The third button, “Back,” allows you to “back out” of lists. It will also cancel a delete, print, save as, or overwrite action.



We have drawn a virtual controller at the bottom left of your screen. In a real application, you will write directly to a PLC, but in this example, you write to the demo driver. The virtual controller helps you visualize how your lists would download to a real PLC.

Three lists appear in the “Active Lists” box - one for each group (excluding the Startup Group). We assigned each group to a pair of columns in the virtual controller. These columns represent separate cards in the controller. The first pair of columns shows the active list for the **Machconf** group. The second pair shows the active list for the **Machset** group. The third pair shows the active list for the **Prod_set** group. You can see which list is active for each group by reading the name listed above the columns in the Active Lists box. Lists can contain several different types of data values, including both analog and discrete.

The virtual controller only shows analog and discrete values, though your lists can also contain ASCII, other lists, or events. The left column in each pair shows analog values, while the right column shows discrete (I/O) values.

The first pair of columns, or card, labeled “CONFIG” shows the values for 3QTRMOLD, the active list of the **Machconf** group.

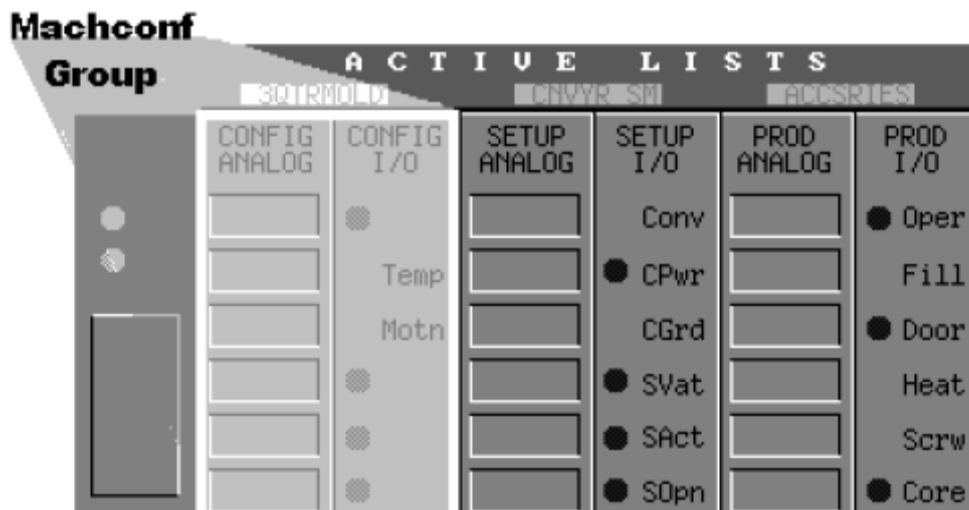

Navigating the Example Application

The MCM Example Application contains three panels. To switch to the next panel, click the right arrow button. To go back to a previous panel, click the left arrow button.



Before you start the following exercises, be sure that you can see the first panel Interact opened when you entered Run Mode, as shown below.

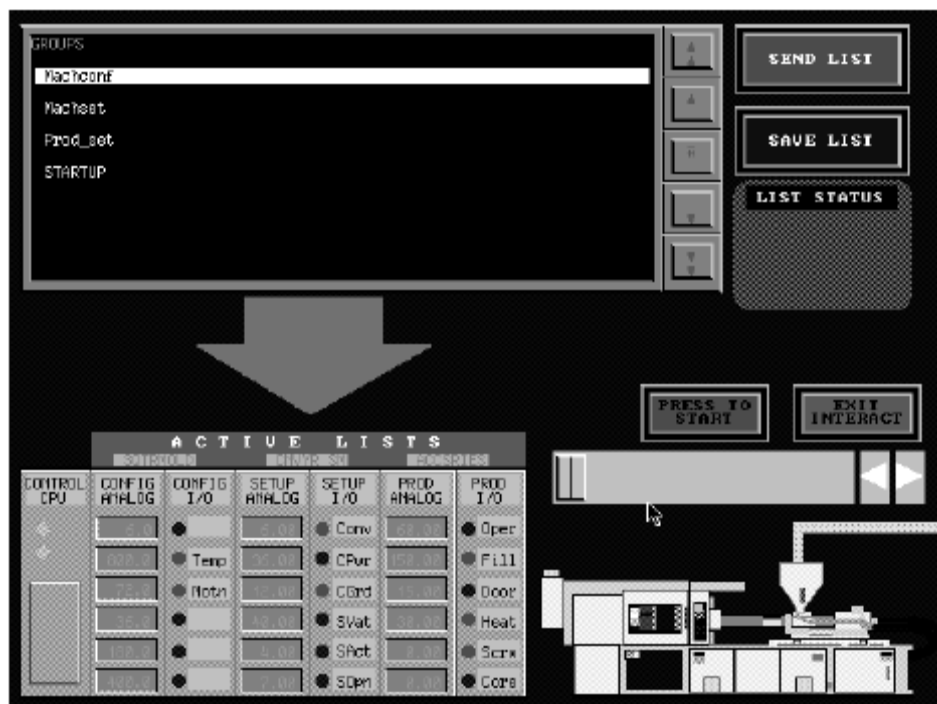

Exploring the MCM Monitor Features

In this section you will observe the MCM example application as it uses the monitor feature. Monitor mode informs the operator of value changes in the controller. To see how it does this, you will change the values from outside the list and observe the changes.

To view the monitor feature of MCM, follow these steps:

1. Click **Machconf** on the Remote List Display tool.

You can see the lists contained in the group MACHCONF.

2. Click **3QTRMOLD** on the Remote List Display tool.

You can now see the list items in the 3QTRMOLD list.

3. Click and drag the slide on the slide tool.



4. Watch the mold close and open as you slide the tool.
5. See the value change for that item in the virtual controller and the Remote List Display tool.

Other monitor cues include the List Status window which shows that a list has changed in the group MACHCONF. The item “72in. forward motion” turns yellow in the Remote List Display tool.

Loading and Sending a List

To load and send a list, follow these steps:

1. Click the **Back** button twice to return to the list of groups.
2. Click **Prod_set** in the Remote List Display tool.

The lists contained in the Prod_set group appear.

3. Click **TMBODIES** to load this list.

MCM loads this list and displays its list items.

Note Notice that none of the values in the controller have changed yet. So far, you have only viewed this list; you have not downloaded any new values yet.

4. Click the **Send List** button and watch the screw assembly engage on the press diagram.

This downloads the list to the demo driver. You will see new values appear in the TMBODIES column on the virtual controller.

Note When you work with a real application, you can see the physical effect of downloading a list to the controller. For this example, we illustrate the effect of downloading a list via a virtual controller and a diagram of a press.

5. Click **Press to Start**.

If you look at the last pair of columns in the virtual controller (the SETUP columns), you will see that the “Oper” I/O item is now lit.

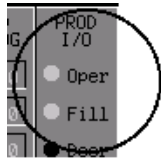

If this was a real application, the mold would begin functioning according to the values it had received in each active list.

Modifying Lists

You can modify lists from Run Time in several ways. You can edit or hot edit them, you can upload new values from the controller, you can delete lists, and you can enable and disable certain items in lists. You will learn about each of these actions in the following section.

Editing Lists

To edit data in a list, follow these steps:

1. Click on **Injection Time** in the Remote List Display tool.

You will see a Numeric Entry Keypad appear.

2. Click **3, 0**; then, click **Enter**. (You can also use your external keypad to enter the numbers.)

The list item Injection Time now has a value of 30. However, this value does not appear in the controller yet. Notice that the item is now yellow and has an asterisk to the left of it. The color alerts you to the fact that item’s value has changed; the asterisk alerts you to the fact that you have not saved it. Also note that in the box labeled “List Status,” an item has appeared, reading that a list in the Prod_set group has changed.

3. Click **Send List**.

The new value now appears in the controller under the TMBODIES column, and the item returns to its original color, although the asterisk still appears.

4. Click **Save List**.

The Save List Message Window shows Tmbodies as the selected list.

5. Click **Accept**.

6. Click **Accept** again.

The list reappears. The asterisk is gone and the newly-saved value appears in the list. The new value is now a permanent part of this list.

Hot Editing Lists

To hot edit a list, follow these steps:

1. Click the **right arrow** button to switch to the second panel in this example application.
2. Click **Hot Edit Off**.

The button should now read **Hot Edit On**.

3. Click the item **Shot Size**.
4. Click the keys on the screen or enter on your external keypad: **2, 5, 0**; then, click **Enter**.
5. Notice that the value reflected in the Remote List Display tool and in the virtual controller's TMBODIES column are identical and match the value you entered.

The virtual controller automatically receives the new value, unlike in the previous example. With the hot edit feature on, you do not need to send a list after changing an item in it. Hot edit sends the new value immediately. (You will see an asterisk by the item in the Remote List Display tool because you have not saved the new value to the list.)

6. Click **Hot Edit On** to turn off the Hot Edit feature.

Uploading Values

1. Click on the mold, the control panel, the screw assembly, and the vat supply pipe.

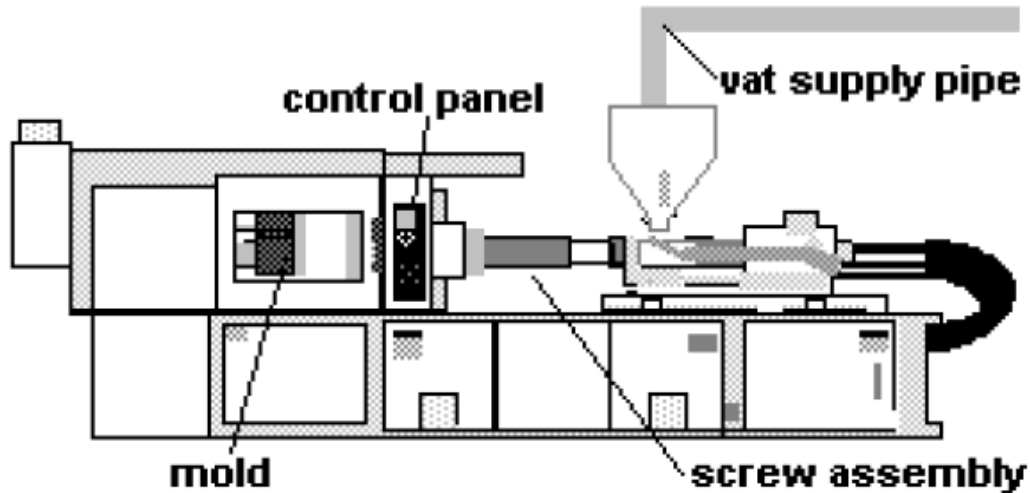

2. Click the **Line Down** button in the Remote List Display tool to view the monitored value for each of these list items. Notice the “door ajar” warning and the changed values in the virtual controller and Remote List Display tool.

Each item affected changed to yellow text, alerting you that their values have changed.

3. Click **Upload List**.

Notice how the Remote List Display changed the appearance of each item, and that the list value is now the same as the monitored value. Each item is now white, but has an asterisk by it to show that its value has changed. Also note the status alert in the List Status box.

Note Each of these items are configured with the “monitor” option enabled. If you configure a list with “monitor with update” enabled, MCM will not only alert the operator when a value has changed, but it will also automatically upload the new values into the list.

4. Click **Save List**.
5. Click **Save List As: TMBODIES**.



You will see an external keyboard entry bar appear at the bottom of your screen.



6. Delete the name **TMBODIES** with your backspace key. Then enter the name **SMBODIES**.

Note You will not see a cursor in this entry bar.

7. Press **Enter**.

Notice that the Remote List Display tool now reads “Save List As: SMBODIES.”

8. Click **Accept**.

Notice that the asterisk is now gone. The list’s name is now SMBODIES, a new list that you derived from TMBODIES.

Enabling and Disabling Lists

Another way to modify a list is to disable one or more list items. This prevents MCM from writing that list item’s value to the controller when you download the list. A disabled item appears dark gray in the list display tool. You can also disable an entire list. You can still view a disabled list, but all the items are grayed out.

To disable a list item, follow these steps:

1. Click the **Back** button to return to the Prod_set list.
2. Click **SM_PARTS**.

Click the **Line Down** button until you have highlighted **Shot Size**.

4. Click **Disable**.
5. Click the **Line Up** button so you can see that the item is now dark gray.
6. Click **Send List**.

Notice that second value in the controller, the one that should receive the new Shot Size, did not update to the SM_PARTS list value of 50.

To enable a list item, follow these steps:

1. Click the **Line Down** button until you have highlighted the disabled item, **Shot Size**.
2. Click **Enable**.

2. Click the **Line Up** button to see that the list item is now the active color, white.
4. Click **Send List**.

Notice that Interact sent the Shot Size item this time and wrote the new value to the virtual controller.

To disable an entire list, follow these steps:

1. Click the **Back** button to return to the Prod_set list.
2. Click the **Line Down** button until you have highlighted **SMBODIES**.
3. Click **Disable**.
4. Click **SMBODIES**.

Notice that every item in the list is dark gray.

5. Click **Send List**.

You will receive a message in the Remote Message Display stating that it could not send the list because of insufficient permission.

6. Click the **Back** button to return to the Prod_set list.

Notice that the list name itself is dark gray.

To enable a list, follow these steps:

1. Click the **Line Down** button until you have highlighted **SMBODIES**.
2. Click **Enable**.
3. Click **SMBODIES**.

Notice that every item is now the active color, white.

4. Click **Send List**.

Interact sent the list and wrote all the values to the virtual controller.

Deleting Lists

We have configured this application to allow users to delete only derived lists in Run Time. SMBODIES is a derived list because you created it from the master list TMBODIES. Therefore, the only list you can delete in Run Time is SMBODIES.

To delete a list, follow these steps:

1. Click the **Back** button to return to the Prod_set list.
2. Click the **Line Down** button until you have highlighted the list **TMBODIES**.
3. Click **Send List**.

You must make another list active before you can delete SMBODIES because you cannot delete an active list.

4. Click the **Line Down** button until you have highlighted the list **SMBODIES**.
5. Click **Delete List**.
6. Click **Accept**.

You have now deleted SMBODIES.

As we stated earlier, you cannot delete master lists. Try deleting one to see what happens.

1. Click the **Back** button so that you can see the names of all the groups in the Remote List Display tool.
2. Click **MACHCONF**.
3. Click the **Line Down** button until you have highlighted the list **3QTRMOLD**.
4. Click **Delete List**.

Notice that the Remote List Display tool will not let you select Accept to actually delete the list.



The dotted box appears around any object that you cannot select. If you try to click this box, nothing will happen.

5. Click **Cancel**.

Using the Remote Message Display Tool

You may have noticed during the last series of exercises that this second panel has a message display tool under the Remote List Display tool. This tool shows descriptions of the lists and groups configured in MCM. This helps you choose the correct group and list.

Viewing Alternate Methods of Using MCM

MCM is a very flexible module. You do not have to use the Remote List Display Tool to view, load, and send lists. The third panel of this application shows you an example of another way to use the module.

Linking PTM Tools to List Items

After advancing to the third panel in this application (by using the right arrow button), take a moment to examine the new layout. The first thing you may notice about this third screen is the



Product Setup Panel.

The various push-buttons and numeric entry tools are linked to specific list items in the Prod_set group. The values you see here are for the current active list in Prod_set, TMBODIES.

To use the Product Setup Panel, follow these steps:

1. Click the **Close** button under "Press Door".

The button should now read **Open** and the **List Changed Press To Save** push-button appears to the far right.

2. Click the **Cool Time** numeric input tool.

An internal keypad entry tool appears.

3. Click **2, 5**; then, click **Enter**.

Notice that the values have not changed in the virtual controller yet. As in the former panel, you must enable hot edit to have your changes download immediately to the controller.

4. Click **List Changed Press To Save**.
5. Click **Send List**.

Single-button Downloads

Another way to send lists is to use single-button downloads. You will notice a set of buttons in in



the middle of the screen.

These buttons will load and send a list as soon as you click one of them.

To use the single-button downloads, follow these steps:

1. Click **QTR_MOLD**, **SUPERVAT**, and **SM_PARTS**.
2. Notice the values shown in the virtual controller.

The lists you just downloaded appear in the I/O along with their values.

Changing User Level

When Interact starts running the MCM example application, it automatically starts at user level 0, the factory level. You can tell which user level you are at by reading the user level display on this third panel.



We have defined three of the 6 levels available. User level 0 allows the most access, providing those with factory clearance access to all lists and all functions except for deleting master lists. User level 3 allows maintenance to view and access the startup, setup, and prod_set groups. User level 5 can only view and access the Prod_set group, and cannot access the cleaning list in that group.

These levels prevent unauthorized personnel from changing and downloading lists they should not touch.

To change your user level, follow these steps:

1. Click **Change User**.

An internal keypad popup appears.

2. Enter the password for user level 3: **3, 3, 3, 3**; then, press **Enter**.

3. Click the **right arrow** key to advance to the first panel.

4. Click the **Back** button to return to the list of groups.

Notice that you can no longer see the Startup group listed in the Remote List Display tool.

5. Click **Machconf**.

Notice that you cannot see any lists in this group. This group is visible to your user level, but you have no access to any of the lists within it.

6. Click the **Back** button.

7. Click the **left arrow** key to get to the third panel.

8. Click **Change User**.

9. Enter the password for user level 5: **5, 5, 5, 5**; then, press **Enter**.

10. Click the **right arrow** key to advance to the first panel.

Notice that you can only see the Prod_set group.

11. Click **Prod_set**.

Notice that the list named **CLEANING** no longer appears.

Note The user levels apply to single-button downloads as well. A level 5 cannot send a list assigned to level 0, even if they can access a screen with a single-button download assigned to the level 0 list.

Modifying the Example Application

In this exercise, you will learn how to:

- Create a simple list named Night consisting of two settings, Screw Heat On and Machine Operation, and a Verify event.
- Download the list to the demo driver and view the results.
- Modify the configuration setup from starting the specified Group to returning to last states.

Returning to the Development Environment

To return to the development environment, follow these steps:

1. Click the **Exit Interact** button.

This will bring you to a custom-designed verification screen which asks if you are sure you wish to exit.

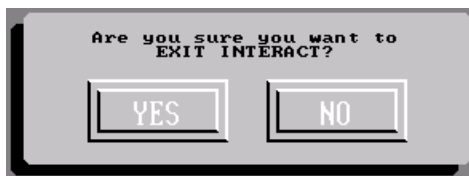

2. Click **Yes**.

You will automatically return to the Windows Application Manager.

Creating a List

To create the list, follow these steps:

1. Double-click the **Machine Configuration Module** icon.
2. Double-click the **Groups** icon.
3. Double-click the **Prod_set** icon.
4. Double-click on **New List**.

The List Item Definitions dialog box appears.

5. Click the **Insert Item** icon on the toolbar.

The List Item dialog box appears.

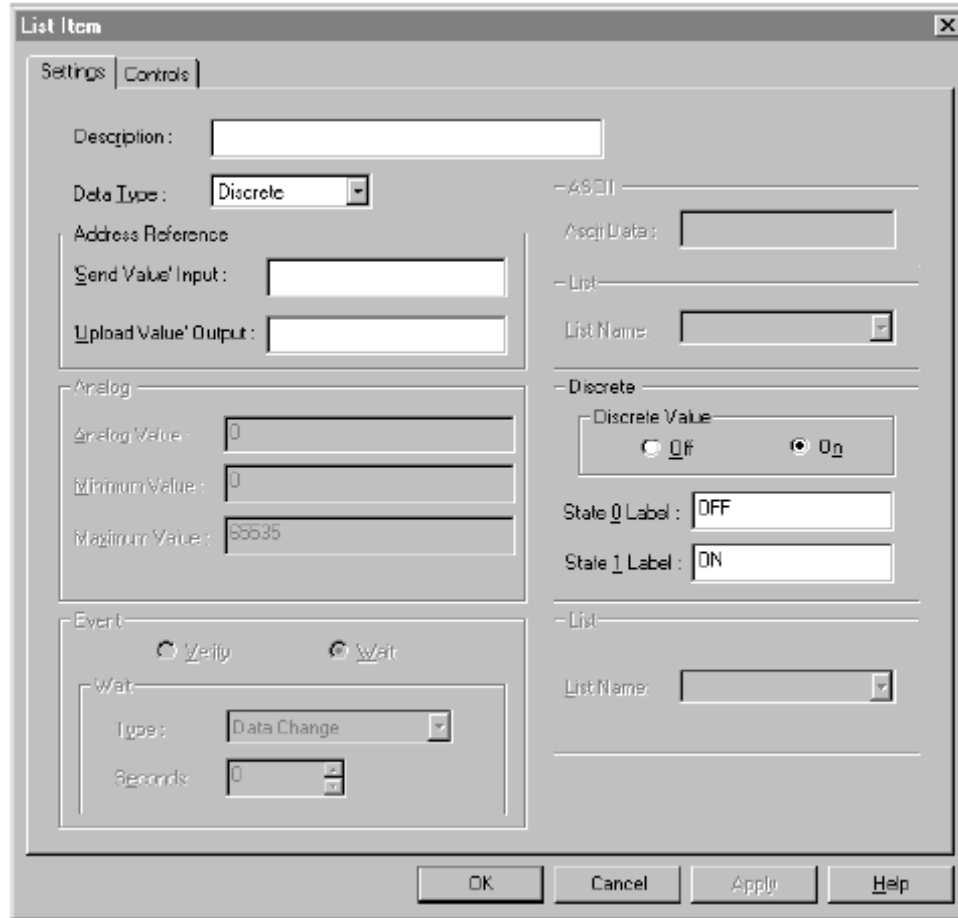

6. Type **Screw Heat On** in the Description box.

This is the description of our first list item.

7. Click the **Data Type** drop-down combo box.

Several options appear.

8. Select **Discrete**.

9. Click the 'Send Value Input' box.

The Address Reference dialog box appears

10. Type **DVR\3:10.1**; then, click **OK**.

This address references the first list item, and is a discrete reference. For more information on address references, see *Address References on page 28*. Notice that the address you entered now appears in the Send Value Input box.

11. Click the **Upload Value Output** box.

The Address Reference dialog box appears.

12. Click the drop-down combo box, select **DVR\3:10.1**; then, click **OK**.

Notice that the address you entered now appears in the Upload Value Output box.

13. In the **Discrete** section, select the **Off** radio button.

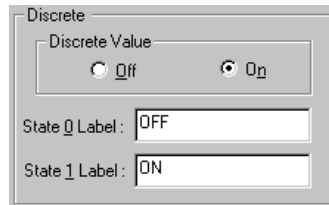

The image shows a dialog box titled "Discrete". It contains a section labeled "Discrete Value" with two radio buttons: "Off" (which is selected) and "On". Below this section are two text input fields: "State_0 Label" with the text "OFF" and "State_1 Label" with the text "ON".

14. Click **OK**.

The completed list item appears in the List Item Definitions window.

Now create the second list entry.

1. Click the **Insert Item** icon on the toolbar.

The List Item Definition dialog box appears.

2. Click the **Description** box, and type **Machine Operation**.

This is the description of the second list item.

3. Click the **Data Type** drop-down combo box.

Several options appear.

4. Select **Discrete**.

5. Click the **Send Value Input** box.

6. Type **DVR\3:10.2**; then, click **OK**.

7. Click the 'Upload Value Output' box.

8. Click the drop-down combo box, select **DVR\3:10.2**; then, click **OK**.

9. In the **Discrete** section, select the **Off** radio button.

10. Click **OK**.

The completed list item appears in the List Item Definitions window.

Now create the third list entry.

1. Click the **Insert Item** icon on the toolbar.

The List Item Definition dialog box appears.

2. Click the **Description** box, and type **Verify**.

This is the description of the third list item.

3. Click the **Data Type** drop-down combo box.

Several options appear.

4. Scroll down, and select **Event**.
5. In the **Event** section, select the **Verify** radio button.

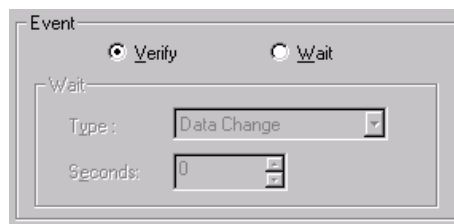

6. Click **OK**.

The completed list item appears in the List Item Definitions window.

Now save the list.

1. Click the **Save** icon on the toolbar.

The Save As dialog box

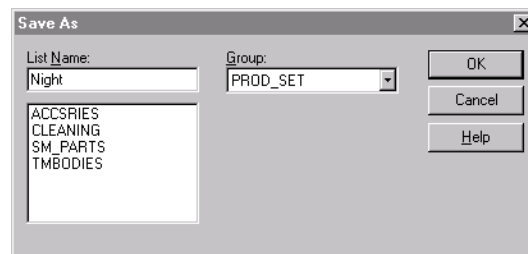

appears.

2. In the List Name box, type **Night**, and click **OK**.

Creating a List Comment

If you create a list comment, that information will appear in the Remote Message Display tool we configured on the second panel.

To create list comment, follow these steps:

1. With the new list still open, on the File menu, and select **Properties, List Properties**.

The Properties window appears.

2. Click in the **Description** box, and type the following message:

Prepares press for inactivity.

3. Click the **Controls** tab.

You can now see the default user level settings for this list. As this is a maintenance task (readying a press for overnight inactivity), we will assign most tasks a user level of 3, as shown below.

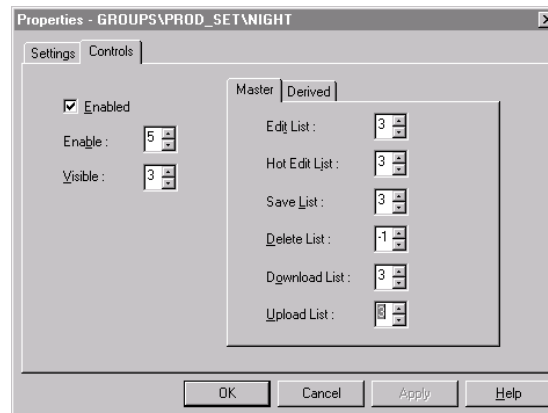

4. Using the arrow buttons beside each setting, change the user level to 3 for the following settings: Visible, Edit List, Hot Edit List, Save List, Download List, Upload List.
5. Using the arrow buttons beside its setting, change the user level of Delete List to -1. This completely disables the delete function.
6. Click the **Derived** tab and set all the user levels to 3 on that tab.
7. Click **OK**.
8. Close the List Item Definitions dialog box; click **Yes** to save your changes.

Modifying the Startup Settings

Before going back into Run Time, you can change the startup settings to “Restore Last State at Startup.” This will cause Interact to return to the last state your application was in before you exited Interact the last time.

To modify your startup settings, follow these steps:

1. Make sure that the Machine Configuration Module item in the Application Browser is open. If not, double-click the **Machine Configuration Module (MCM)** icon.
2. Double-click the **Machine Configuration Setup** icon.

The Machine Configuration Setup dialog box appears. You only need to change the first two items in this window.

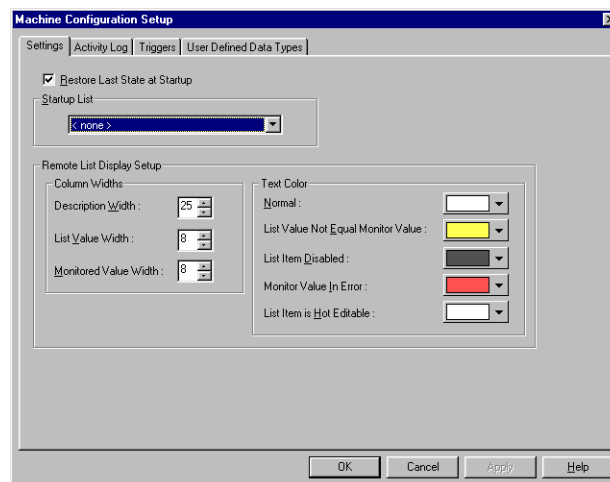

3. Click the check box next to **Restore Last State at Startup**.
4. Click the drop-down combo box under Startup List and select **None**.
5. Click **OK**.

Testing the Example Application

Now that you have used the Machine Configuration Module (MCM) and configured groups and lists, you are ready to test the application.

Returning to Run Mode

To return to Run Mode, follow these steps:

1. From the **Application Browser**, click the **Application Manager** icon.

2. On the **Run** menu, click **Run Interact**.
3. Click **Yes** when you are asked to save changes.

Viewing the New Startup Configuration

Notice that the active lists now in the controller are not the three startup lists from the first time you entered Run Mode. Instead of 3QTRMOLD, CNVYR_SM, and ACCSRIES, you now see QTR_MOLD, SUPERVAT, and SM_PARTS.

Sending the New List to the Controller

To load the new list and send to the controller, follow these steps:

1. Click **Prod_set** in the Remote List Display tool.
2. Click the **right arrow** button to advance to the second panel.
3. Click the **Line Down** button to highlight **Night**.

The comment you entered in the description box appears in the Remote Message Display tool.

4. Click on **Night**.

Night now appears as the selected list.

5. Click **Send List**.

Notice that your new list's values appear in the virtual controller.

6. Click **Exit Interact**; then, click **Yes** to return to the development environment.

Experiment!

This chapter provides only a brief introduction to the features of MCM. The best way to learn is to experiment.

- Try configuring a different list to run when you start up MCM.
- Load the other lists in the example application, and view them on the example panel.
- Practice more with disabling/enabling lists and list items.
- Try using the wait event as a list item
- Change the user level settings on your groups and lists, both master and derived.
- Press View Activity on the Run Mode screen to view the list log file.

Report Module

The Report Module (RPM) allows you to create custom reports for any Interact application. With RPM, the operator can preview real-time data reports on the display screen during online operation. RPM can send reports to floppy drives, networks, printers, or ASCII text files. With these functions, RPM allows you to create and store reports easily and efficiently.

This chapter provides an overview of RPM. An example is provided that shows you how to incorporate a sample report within an application. The example application goes through potential uses for RPM and leads you through creating a sample report.

Chapter Contents

<i>Overview of RPM</i>	191
<i>Important Concepts</i>	191
<i>Overview of the Example Application</i>	196
<i>Running the Example Application</i>	197
<i>Modifying the Example Application</i>	205
<i>Testing the Example Application</i>	208
<i>Experiment!</i>	209

Overview of RPM

RPM is an optional software program that runs under the control of the Interact Application Manager (AM). RPM has several unique features that assist you in generating your reports. These features are listed below:

- Report Form Editor - Use the Report Form Editor to create a report template for your data.
- Scroll horizontally - Use the horizontal scroll buttons to scroll report data on the display that is greater than 80 columns wide.
- View real-time data - Use the View Report display to view report text and real-time data as it is updated in Run Mode.
- Group variables - Create groups of variables to sum or average columns and rows of data.
- Input data - Configure the report to allow an operator to input ASCII or numeric data online. This data does not go into the controller.
- Track data - Monitor data over time to count or time the occurrence of an event and track high and low values.
- Generate reports automatically - Configure RPM to automatically send the report to a printer or disk file at a particular time or when the data changes.

Important Concepts

The following are important concepts you will need to know as you use RPM.

Forms

Report forms define the text and variable data that are sent to a printer or disk when the report is generated. In the development environment, you enter text and variable data references directly on the form. During Run Mode, real-time data is read into the report at the positions you configure in the development environment.

Variables

Variables are data fields that you enter in the report form. Each variable type is configured by positioning the text cursor in the Report Form Editor screen and selecting the Insert Variable command from the Edit menu. They can be one of the following:

- Numeric Value - displays data read from the controller
- Group Value - displays the Current Low Value, Current High Value, Historical Low Value, Historical High Value, Sum, Average, or Time Sum amount of several numeric or operator variables. Numeric or operator group variables may be assigned to one or more groups.
- Stored Message - references a message you create and is taken from the RPM.MSG file
- ASCII Text - displays data read from the controller
- Operator Input - ASCII or numeric data that is entered by the operator
- User Name - enters the user's name in the report
- Page Number - enters the page number in the report
- Start Time - enters the start time in the report using the HH:MM:SS format
- End Time - enters the end time in the report using the HH:MM:SS format
- Start Date - enters the start date in the report using either the MM/DD/YY or DD/MM/YY format
- End Date - enters the end date in the report using either the MM/DD/YY or DD/MM/YY format
- Color Control - changes the report text to a specific color
- Printer Control - text attributes recognizable by your printer such as italics, bold, underline, etc.

Groups

A group is a collection of variables whose values are combined for analysis. This allows operations to be performed on a collection of variables at the same time. You can take the Current Low Value, Current High Value, Sum, Average, Historical Low Value, Historical High Value, or the Time Sum of a set of data.

Groups are assigned a specific function that is performed on all members assigned to this group. For example, you could name a group "COLUMN1." If the function assigned to this group was the Sum, then this group variable would sum all numeric and operator variable data assigned to the COLUMN1 group of your report.

Once you create a group (add it to the Group List) you can assign Numeric Value, Group Value, and Operator Input variables to it. You can also assign groups to other groups, creating sub-totals and grand totals.

Stored Messages

When you create a report form, you can store message variables in the form. The message variable references the messages you created using the Stored Message command on the Settings menu. When you create a new message, you assign a number to it that the message variable references during Run Mode.

Text for stored messages resides in a file named RPM.MSG. All reports in an application reference the same message file. This file can either be loaded into your computer's system memory or read from a disk upon entering Run Mode. This depends on the Message Storage parameter on the General page of the RPM Setup property sheet.

You can configure the stored message variable to reference either the message number (reference type set to Constant) or an address (reference type set to Variable) which RPM will monitor to obtain the message number. Placing the message number at the monitored address will display the associated message.

Report Triggers

A report trigger is the method used to generate a report that can be sent to a disk file or printer. There are eight methods available to trigger a report. The trigger methods are listed below:

- Manual Only
- Minute Interval
- Hour Interval
- Day Interval
- Day Span
- Week Span
- Data Change
- Positive Edge

Several trigger methods only allow you to specify the interval when a report is generated and sent to a printer or disk. This moment is specified at the trigger interval. Other trigger methods also allow you to specify when data collection should begin and end for the report. Data collection refers to the length of time an event or value is monitored.

Trigger Intervals

Trigger intervals control when a report is triggered. Trigger intervals include a start time or day of the week and the interval specified in minutes, hours, or days. Use the Trigger page of the Report Preferences property sheet to configure the trigger interval. The Trigger Method you select determines the available options for configuring the trigger interval.

- Manual Only - no trigger interval
- Minute Interval - specifies the Start Time and Interval in minutes

- Hour Interval - specifies the Start Time and Interval in hours
- Day Interval - specifies the Start Day-of-Week, Start Time, and Interval in days
- Day Span - specifies the Start Time and End Time in hours
- Week Span - specifies the Start Day and Time and an End Day and Time
- Data Change - specifies the address you want to monitor that will trigger the report when the data changes
- Positive Edge - specifies the address you want to monitor that will trigger the report when the data makes a False to True transition

File Numbers

Report files are created by RPM during Run Mode. Report files consist of the text and variables that were configured for the report in the development environment. As report files are created, they receive a sequential file extension number beginning with R01 and incrementing to a maximum of R99. You specify the maximum number using the Maximum Files parameter on the General page of the Report Properties property sheet.

Once the report file reaches the maximum file number, the next saved report will overwrite file number R01. For example, if you set the maximum file number to 20 and you name the report form EXAMPLE, RPM creates files EXAMPLE.R01 through EXAMPLE.R20. The next report RPM saved after EXAMPLE.R20 will be EXAMPLE.R01.

User Levels

During configuration, you can assign user levels to restrict operators from using some or all of the functions critical to the operation of RPM. Interact supports six user levels numbered from 0 to 5. User level 0 is the highest user level, offering the most privileges; user level 5 is the lowest user level, offering the least privileges.

To restrict operators from using a function, each operator is assigned a user name. The user name is then assigned a user level that defines the operations available to each operator. For more security, you can assign each user level a unique alphanumeric password in the Application Manager. Passwords must be between 1 and 15 characters long.

Run Mode

In Run Mode, the device driver and all Interact modules for the application load and begin running. All report features are active, and you can begin generating reports.

Report View Display

This screen allows you to view your report files. This is the first screen that appears when you enter the Run Mode. Initially, the Report View Display is blank, since no reports have been loaded.

After loading a report, the data monitored is displayed on the screen. The top portion of the display provides information on the loaded report.

Features available from this display let you:

- Scroll horizontally and vertically through a report file. This allows you to view reports that are greater than 80 columns wide.
- Go to the Report Load or Report Control Displays
- Go to the Next Module, Previous Module, use the selected module, or return to AM
- Print the currently displayed report file
- Save the currently displayed report file

Report Load Display

The Report Load Display enables you to load your report files. This screen appears only after selecting Load Report from the Report Display.

A selection box follows the cursor as you move it over the report files. The top portion of the display provides information on each report. The report name, number of files within the report, and the start and end time is listed on this heading.

Features available from this display let you select individual files of a report and return to the Report View Display.

Report Control Display

The Report Control Display enables you to control various report features during Run Mode. This screen appears only after selecting Report Control from the Report View Display.

A selection box follows the cursor as you move it over the report files. The top portion of the display provides information on each report file.

The following features are found on each report display:

- Total number of files in the report
- The start and end time of these files
- Current file number
- Whether the report is active/inactive and enabled/disabled
- Total size of all files in the report
- Current report log path
- Printer status

The features available on this display allow you to do the following:

- Enable or disable reports. A disabled report can't be printed, loaded, or saved, but still collects data.
- Reset a report. Resetting reports affects all Numeric variable data collected to date and resets these values back to zero.
- View messages associated with a report
- Return to the Report View Display
- Go to the Next Module, Previous Module, user selected module, or return to the AM
- Toggle printer status
- Change to a new disk. This is used in backing up your report files.
- Erase all report files associated with a specific report
- Back up report files

Overview of the Example Application

The following sections provide hands-on experience using the Report Module (RPM). The example application, Rpmexamp, consists of a preconfigured report form. In a real application, a report form would be configured to generate a report of data from addresses in your controller. The report form in this example is configured to generate a report from the data written by tools on the Panel Toolkit Module to the Interact Demo driver.

You will explore the example application in several ways:

- Load the example application
- Load a Report Form
- Observe the report in Run Mode
- Enter an operator message into the report
- Save the report file
- Go to the PTM module
- Go to the Report Control Display
- Edit the report in the development environment
- Test the modified example

Note This example assumes you have the Panel Toolkit Module (PTM) installed on your system and that you are familiar with its operation. If you are unfamiliar with PTM, refer to Chapter 5 of this manual.

Running the Example Application

To run the example, follow these steps:

1. Launch Interact from the MachineShop toolbar.
2. On the **File** menu, select **Open Application**.

A list of available projects appears.

3. Double-click the **APPFILES** folder.

The APPFILES folder opens.

4. Click **Rpmexamp**; then, click **OK**.

The Application Browser appears with the Rpmexamp application loaded.

5. On the **Run** menu, select **Run Interact**.

6. Click **Yes** when you are asked to save changes.

You enter the Interact Run Mode. The PTM panel used with this example appears.

Note This application was configured to go into Run Mode when the Run Interact option is selected. Use the Startup Mode parameters configured on the Application Settings property sheet to configure which mode, module, and startup user will be active upon entering Run Mode. For this application the PTM panel used with this example is the first Run Mode screen displayed.

Loading the Report Form

First you will explore the features of the Report Module by loading and displaying a report form.

To load a report form, follow these steps:

1. Select the **Go To Report Module** button.

The Report View Display appears.

2. Click on **Load Report** located in the lower left of the screen.

The Report Load Display appears.

3. Place the selection box over **Example**, and click.

The report file is highlighted.

4. Click on **Accept**.

The report file Example is loaded and shown on the Report View Display as shown below:

21:10:57 REPORT: EXAMPLE (Current) PG. 1 OF 1

 PRODUCTION STATUS REPORT

 Start Time: 13:01:11 End Time: 21:10:53
 Operator: RICH 2345

DESCRIPTION	LINE	GOOD PARTS	BAD PARTS	% YIELD	DOWNTIME	STOPS
Clamp	1	876	3	99.66	00:00	0
Hinge	2	349	18	95.10	06:49	0
Screw	3	575	231	71.34	00:00	0
Knob	4	427	9	97.94	06:49	0
Wing Nut	5	127	6	95.49	00:00	0
Cotter Pin	6	12	2	85.71	06:49	0
Spring	7	127	7	94.78	00:00	0
Clip	8	63	21	75.00	06:49	0
Total Parts		2556	297	89.38%	00:27:16	0

Operator Message: NONE

The word “Current” appears after the file name indicating this is the most recent file.

Observing the Report

Look closely at this report. Various color codes are assigned to the report to help distinguish between each section of the report.

The report was configured by creating columns of text using the Report Form editor. Variables are inserted in the report at specific locations. Each parameter and column located on the report is described in the following paragraphs.

Start and End Time

The Start and End Times are predefined variables. Start Time refers to the time at which data collection began for this report file. End Time refers to the time the report was actually generated.

Operator

The Operator variable is predefined and inserts the user name into the report.

Good Parts

The eight variables listed under the Good Parts column are numeric values assigned to an address. Three of these numeric variables are assigned to the demo driver timers. These are the values that

are changing.

Numeric Entry tools located on the PTM panel created for this example write data to the assigned addresses. The addresses are then monitored and written to the report.

These eight variables are assigned to the Goodparts group. This is done so you could easily take the sum of this column.

Bad Parts

The eight variables listed under the Bad Parts column are numeric values assigned to an address.

Numeric Entry tools located on the PTM panel created for this example write data to the assigned addresses. The addresses are then monitored and written to the report.

These eight variables are assigned to the Badparts group. This is done so you could easily take the sum of this column.

% Yield

This column takes the number of good parts, divides it by the total number of parts, and multiplies this value by 100%. The result is the percent yield each line is producing.

The variables are Numeric Values assigned to the Yield group.

Downtime and Stops Columns

The numeric variables located under the Stops column are assigned to eight Maintained Push Buttons located on the PTM panel created for this example. Each production line has a Push Button assigned that, when pressed, will stop the line. Each time a line is stopped, the Numeric Value variable located under the Stops column applies the Count function to this address. This will keep track of the number of times the line was stopped.

The numeric variables located under the Downtime column apply the Timed function to the same address assigned for each corresponding Stop column variable. The Timed function starts a counter that indicates the duration in minutes and seconds that the line is down.

All variables located under the Downtime column are assigned to the Downtime group. All variables located under the Stops column are assigned to the Stops group.

Total Parts

This row consists of group variables that have a specific function applied. Total good parts are derived from taking the sum of all variables belonging to the Goodparts group. Total bad parts are derived from taking the sum of all variables belonging to the Badparts group. Total number of stops is derived from taking the sum of all variables belonging to the Stops group.

Notice also the total downtime accumulated for each line. The group variable located under the

Downtime column takes the sum of all the times belonging to the Downtime group.

You can also see the average percent yield this process is producing. The group variable located under the %Yield column takes the average of all variables belonging to the Yield group.

Entering an Operator Message

Reports can have operator messages attached to them. An Operator Input variable has been inserted next to the Operator Message parameter. This allows you to enter ASCII text.

To enter a message, follow these steps:

1. Move the cursor over the word **None** next to the **Operator Message** parameter located at the bottom of the display.

This area of the report is highlighted.

2. Click the word **None**.
3. Enter a message.
4. When finished, click the **right mouse** button, or press **Enter**.

The message entered is now part of the current report.

Saving Reports

To save a report, follow these steps:

1. Click on **Save Report** located at the bottom center of the display.

A message, similar to the one shown below, is displayed in the Message Window indicating the report is being saved.

```
SAVING EXAMPLE.R01
```

Once the report is saved, a message similar to the one shown below is displayed in the Message Window indicating the save operation is complete.

```
EXAMPLE.R01 SAVED
```

Reports can also be configured to be saved automatically based on time or events. Each time a report is saved, the file number is incremented by 1. Once the Maximum File Number is reached, the next saved file will overwrite the first file number.

2. Clear the message in the **Message Window** by clicking anywhere inside the window.
- 2.

Going to PTM

Now go to the PTM module, change some values, and observe the results.

To go to PTM, follow these steps:

1. Click on the **left arrow** button, located in the lower left corner of the display.

The PTM panel is displayed as shown below:

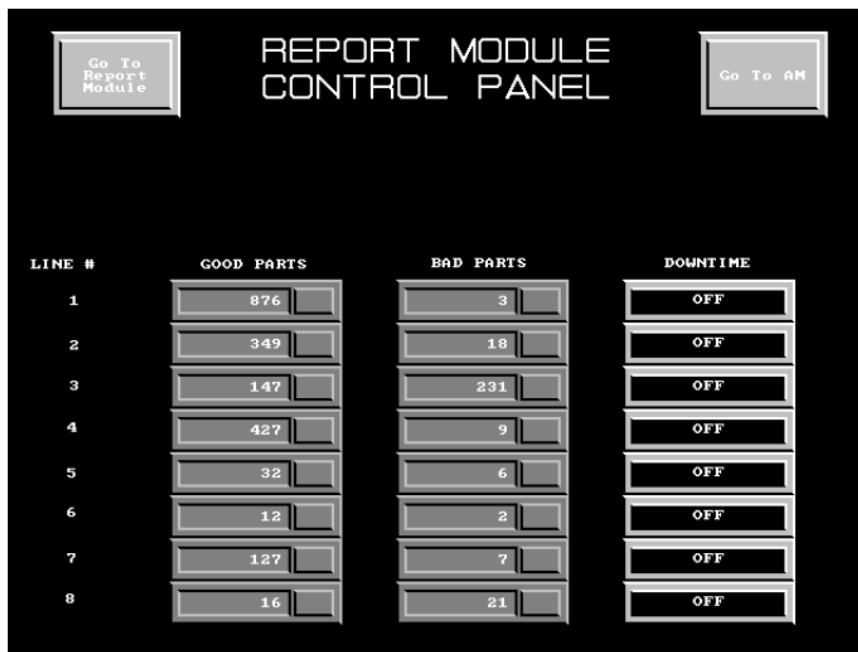

The eight Numeric Entry tools on the far left side adjust the number of good parts the respective line is producing. The eight Numeric Entry tools in the center adjust the number of bad parts the respective line is producing.

2. Click on line number 1's **Good Parts Numeric Entry** tool.

A Numeric Keypad is displayed.

3. Click **9, 0, 0**; then, click **Enter**.

This value is displayed on the tool.

4. Click on line number 1's **Bad Parts Numeric Entry** tool.

A Numeric Keypad is displayed.

5. Click **4, 5, 0**; then, click **Enter**.

This value is displayed on the tool.

6. Now click on line numbers 2, 4, 6, and 8's **Downtime Maintained Push Buttons** located on the far right side of the display.

Button lens labels will change to On.

7. Return to RPM by clicking on **Go To Report Module**.

Notice the new values you entered for line number one are now displayed. Because the %Yield column is calculating the ratio of good parts to bad parts, the percent yield has changed for line number one. This also affects total percent yield.

The number of times lines 2, 4, 6, and 8 were stopped is shown under the Stops column. The total number of times all lines were stopped is shown at the bottom of the column.

Since these lines are down, the Downtime column indicates the number of minutes and seconds these lines are down. The total downtime for all lines is shown at the bottom of the column.

Viewing the Report Control Display

Use the Report Control Display to do the following:

- Enable/disable reports
- Reset reports
- Backup reports
- Erase reports
- Change to a new disk for report logging
- Control the printer

This section leads you through enabling/disabling reports, resetting reports, and controlling the printer.

Enabling/Disabling the Report

To enable or disable the report, follow these steps:

1. From the **Report View Display**, click **Report Control** located in the upper right corner of the display.

The Report Control Display appears as shown below:



2. Move the selection bar over report **Example**.

3. Click on the report.

The report is highlighted.

4. Click the **Report Enable/Disable** button located in the upper left corner.

This toggles the report between Enabled and Disabled. A disabled report can not be saved or printed. The report text indicates the state of the example either Enabled or Disabled.

5. Click on **Report Enable/Disable** until the report is **Enabled**.

Resetting the Report

Use the Reset Report feature to reset any numeric or operator input variables that use the Count function to 0.

To reset the report, follow these steps:

1. Move the selection bar over report **Example**.

2. Click on the report.

The report is highlighted.

3. Click the **Reset Report** button located next to the Message Window.
4. Click on the **Leave Control** button located in the upper right corner of the screen to leave the Report Control Display.

The Report View display appears. Look at the Stops column. Since the variables under this column are Numeric Variables with the Count function applied, they are now reset to 0.

Your downtime values will continue to grow if you activated the Downtime buttons on the PTM screen. Resetting the report merely starts the timer back at zero again.

5. Click on the **Report Control** button to return to the Report Control Display.

Controlling the Printer

To control the printer, follow these steps:

1. Move the selection bar over the **Example** report.
2. Click on the **Example** report.

The report is highlighted.

3. Click on the **Printer Ctrl** button located in the lower right corner of the display.

The report printer status (LPT1) toggles between On and Off. The Message Window indicates printer status along with the text associated with the highlighted example.

4. Click on the **Leave Control** button to return to the Report View Display.

Modifying the Example Application

In this part of the example, you will enter the development environment and add variables to the existing report. You will then enter Run Mode and load the modified report.

Returning to the Development Environment

To return to the development environment, follow these steps:

1. From the **Report View Display**, click **Go To AM** to return to the Application Manager Main Menu.
2. Click **Exit Interact**; then, click **Accept**.

The Interact Application Manager window is displayed.

Loading the Report Form

To load the report form, follow these steps:

1. Double-click on the **Report Module (RPM)** icon.
2. Double-click on the **Reports** icon.

All reports created for this application are listed.

3. Double-click on the **Example** icon to open up the example report form.

Adding Variables to the Report Form

The Example report configuration is shown with all variables inserted in the form. In the next steps, we will add variables to this form.

To add variables to the report form, follow these steps:

1. On the **View** menu, click **Color/Printer Codes**.

This will show all color and printer codes that have been added to the report. Any text inserted in the form after (to the right of and below) a color code will appear in the specified color or until another color code variable is encountered.

In this exercise you are interested in the lowest and highest yields this process has generated. Thus, you will add variables that check for these values.

Once this exercise is completed, the report form will appear as shown below. Use this figure as a guide while following the steps below.

DESCRIPTION	LINE	GOOD PARTS	BAD PARTS	% YIELD	DOWNTIME	STOPS
Clamp	1	#####	#####	###.##	##:##	####
Hinge	2	#####	#####	###.##	##:##	####
Screw	3	#####	#####	###.##	##:##	####
Knob	4	#####	#####	###.##	##:##	####
Wing Nut	5	#####	#####	###.##	##:##	####
Cotter Pin	6	#####	#####	###.##	##:##	####
Spring	7	#####	#####	###.##	##:##	####
Clip	8	#####	#####	###.##	##:##	####
Total Parts		#####	#####	###.##%	##:##:##	#####
		Lowest Yield:		###.##	Highest Yield:	###.##
Operator Message: #####						

To accomplish

this you will do the following:

- a. Insert text identifying the lowest and highest yield for our process.
 - b. Add group value variables assigned to the new group.
 - c. Assign the Low and High functions to the new group variables. This will display the lowest and highest yields of our process.
2. Place the cursor between the **Total Parts** row and **Operator Message** row.
 3. Press **Enter** to create an additional row.
 4. Move the cursor (press the space bar) until it is under the far left digit of the Good Parts column.
 5. Type **Lowest Yield:**

The text will appear red because the color code inserted above the Total Parts line is set to red.
 6. Move the cursor (press the space bar) to the right until it is under the far left digit of the % Yield column.
 7. On the **Edit** menu, click **Insert Variable**.
 8. Click **Group Value**.

The Group Variable dialog box is displayed as shown below:

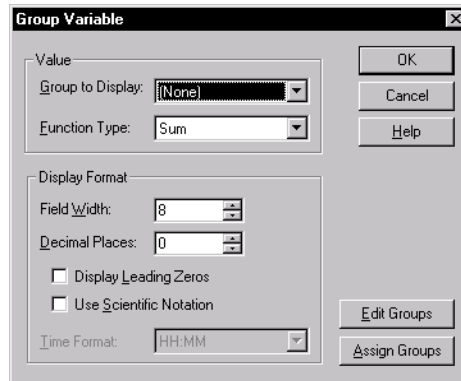

9. Click on **YIELDHL** in the Group to Display box.
10. Click on **Historical Low Value** in the Function Type box.
11. Type **6** in the Field Width box.
12. Type **2** in the Decimal Places box.
13. Click **OK**.

You return to the Report Form Editor with the group variable added.

14. Move the cursor (press the space bar) under the far left digit of the Downtime column.
15. Type **Highest Yield:**
16. Click on the group variable you just added, next to **Lowest Yield**.

You will copy and paste this variable next to the Highest Yield parameter.

17. On the **Edit** menu, click **Copy**.
18. Move the cursor (press the space bar) under the far left digit under the Stops column.
19. On the **Edit** menu, click **Paste**.

A copy of the group value variable you added is inserted next to the Highest Yield parameter.

20. Click on the variable you just copied under the Stops column.
21. On the **Edit** menu, click **Edit Variable**.

The Group Variable dialog box appears.

22. Click on **Historical High Value** in the Function Type box.

Since this is a copy of the Lowest Yield parameter, you do not have to change the Field Width or Decimal Places parameters.

23. Click **OK**.

The Report Form Editor is displayed. You are now finished editing the report form. Now save your changes, following the next set of steps, and add this report to the Report List so your application is able to load the report.

Saving the Report Form Changes

To save the changes, follow these steps:

1. On the **File** menu, click **Save Report As**.

The Save As dialog appears.

2. Type **Example1.rpm** in the Report Name box.
3. Make sure the **Add to Report List** box is selected.

This allows the Example1 report to be used in Run Mode.

4. Click **OK**.
5. On the **File** menu, click **Close Module**.

This closes the Report Form Editor, and the Application Manager appears.

Testing the Example Application

Now that you have used the Report Module (RPM) and created a report, you are ready to test the application.

Returning to Run Mode

To return to Run Mode, follow these steps:

1. From the Application Browser, click the **Application Manager** icon.
2. On the **Run** menu, click **Run Interact**.
3. Click **Yes** when you are asked to save changes.

The PTM panel used in this application appears.

Loading the Report Form

To load the Report Form, follow these steps:

1. Select the **Go To Report Module** button.

The Report View Display appears.

2. Click the **Load Report** button located in the lower left of the screen.

The Report Load Display appears.

3. Move the selection bar over **EXAMPLE1**, and click. The report form is highlighted.

4. Click on the **Accept** button.

The Report View Display is shown with variable data inserted in the form. Notice the group value variables you added.

Experiment!

This chapter provides only a brief introduction to the features of RPM. The best way to learn is to experiment.

- Go back into the development environment, and add variables to the report form. You can also change the functions assigned to the numeric variables.

User Program Module

The User Program Module (UPM) is designed to allow a user-written terminate-and-stay-resident (TSR) program, called the User Program, to share data with Interact. Interact allows user-written TSR's to be easily added into Interact's standard architecture and provides the user-written TSR program with its own interrupt for efficient operation in the real-time environment.

This chapter provides an overview of UPM. An example is provided that shows you how to use a TSR developed with UPM within an application.

Chapter Contents

<i>Overview of UPM</i>	211
<i>Important Concepts</i>	211
<i>Overview of the Example Application</i>	213
<i>Exploring the UPM Example Application</i>	214
<i>Modifying the Example Application</i>	218
<i>Testing the Example Application</i>	220
<i>Experiment!</i>	222

Overview of UPM

UPM communicates with the User Program via a software interrupt. The User Program communicates with other Interact modules and drivers through a shared memory area. The following graphic illustrates how UPM and the User Program fit into the Interact architecture.

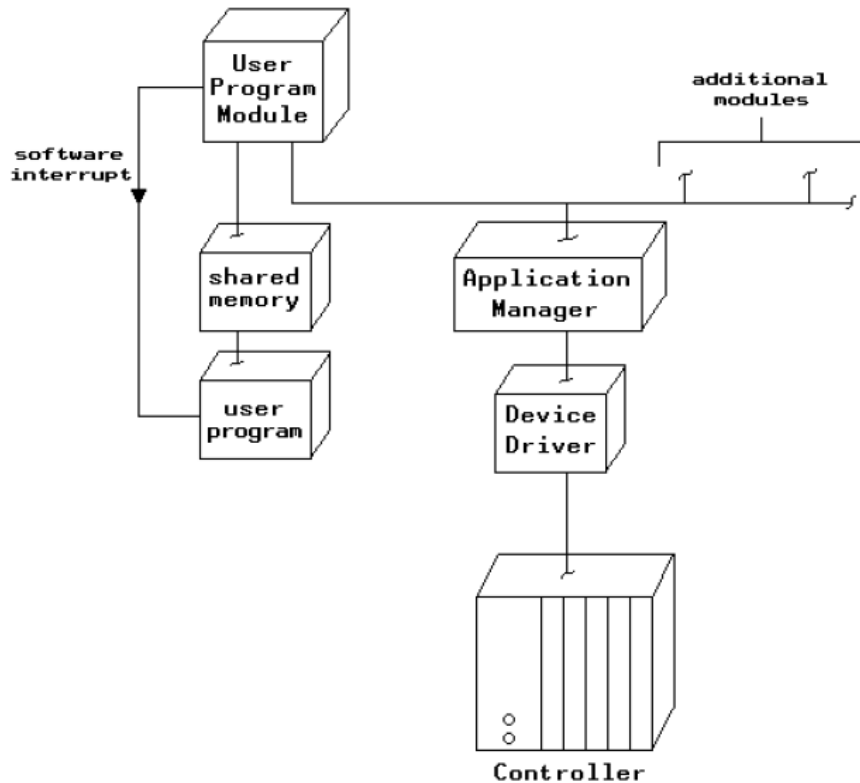

Important Concepts

The following are important concepts you will need to know as you use UPM.

User Program

The term User Program refers to the user-written TSR program that must be loaded into memory before running the Interact Application Manager.

User Interrupt

UPM interrupts the User Program to give it processing time and to send or receive data. During configuration you define the user interrupt number (60 through 67 hex), which must match the number expected by the User Program.

Trigger

The trigger defines when a specific stimulus will cause UPM to interrupt the User Program. You are allowed to configure three trigger conditions, any one of which will cause UPM to interrupt the User Program. The conditions include the following:

- Data change on any of the output address references being monitored by the User Program
- Data change for a specific address reference
- Time interval

Output List

The Output List is a list of output address references that you want the User Program to monitor. UPM moves changing data values for these references into a shared memory area, called the Output Array, that the User Program may access. The diagram below illustrates the Output List's relationship to UPM and the User Program.

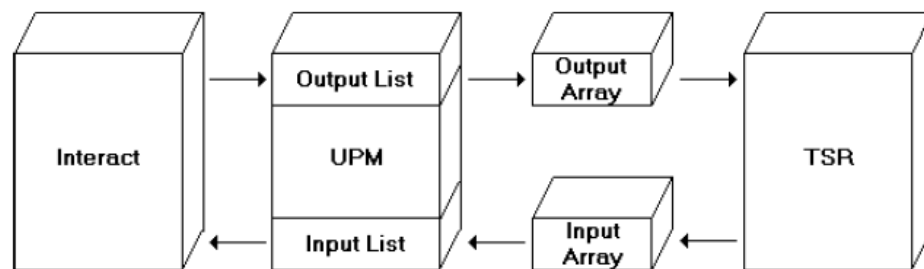

Input List

The Input List is a list of input address references to which the User Program may send new data values. The User Program writes data into a second shared memory area called the Input Array, which UPM then moves to the corresponding input references in the Input List. The diagram above illustrates the Input List's relationship to UPM and the User Program.

Monitor Screen

This is the runtime screen displayed by UPM. It shows the current data values and error status for the references in the Input and Output Lists. The Monitor Screen is provided as a diagnostic tool.

User Screen

This is an optional runtime screen displayed by the User Program to provide its own information to the operator. If the User Screen is supported, the operator can view it by selecting a button on the Monitor Screen. If desired, the User Screen can be configured to be the only screen the operator can access when UPM is in the foreground, therefore bypassing the Monitor Screen completely.

Run Mode

To go to Run mode, the TSR User Program must already have been installed in memory before running the Application Manager. Once a TSR program has been installed, it remains in memory until the system is rebooted. However, most TSR programs provide a command-line option that allows their removal from memory without having to reboot.

Once the TSR is in memory, you can repeatedly run Interact and switch between development and runtime without having to re-install the TSR.

In Run Mode, when you press the Go To Module button and select UPM, either the Monitor Screen or the User Screen will be displayed. The Monitor Screen provides a button which the operator may press to view the User Screen, if supported. This button is enabled on the Display page of the UPM Setup property sheet in the development environment.

The User Screen is totally under the control of the User Program and may consist of text, graphics, or a combination of the two. The operator may even be prompted for input when viewing the User Screen. Consult your User Program supplier for information about the User Screen operation.

Overview of the Example Application

The following sections provide hands-on experience using the User Program Module (UPM). This example consists of an application, Upmexamp, which has been configured to operate with “TSR.EXE,” an example TSR program.

You will explore the example application in several ways:

- Place a reference to TSR.EXE in your Autoexec.bat file
- Load the UPM application
- View the Monitor and User Screens
- Change inputs and observe the results
- View the related PTM panel
- Edit the Output List
- Test the modified example

Note This example assumes you have the Panel Toolkit Module (PTM) installed on your system and that you are familiar with its operation. If you are unfamiliar with PTM, refer to Chapter 5 of this manual.

Exploring the UPM Example Application

Now that you have had an overview of the User Program Module (UPM), you are ready to take a look at the example application.

Modifying Your Autoexec.bat File

Before running Interact, you must load the User Program. You must modify your Autoexec.bat file for this example to work properly.

To modify your Autoexec.bat file, follow these steps:

1. Make a copy of your current Autoexec.bat file.
2. Using a text editor, modify your Autoexec.bat file to load the example TSR upon rebooting the computer. Add a line to your Autoexec.bat file which is the path where the TSR resides. The line below assumes the TSR is located at the default path.

C:\INTERACT\APPPFILES\UPMEXAMP\TSR.EXE

3. Save the change and restart your computer.

When the TSR has finished loading, the message below will appear.

```
TSR Test Program for Interact User Program Module
Version EX-XXXXXX-XXX
TSR has been installed at interrupt 61 hex.
```

Running the Example Application

To run the example, follow these steps:

1. Launch Interact from the MachineShop toolbar.

2. On the **File** menu, click **Open Application**.

A list of available projects appears.

3. Double-click the **APPFILES** folder.

The APPFILES folder opens.

4. Click **Upmexamp**; then, click **OK**.

The Application Browser appears with the Upmexamp application loaded.

5. On the **Run** menu, click **Run Interact**.

6. Click **Yes** when you are asked to save changes.

You enter the Interact Run Mode. The PTM panel used with this application is displayed.

7. Select the **Go To UPM** button.

The UPM Monitor Screen is displayed as shown on the following page.

Note This application was configured to go into Run Mode when the Run Interact option is selected. Use the Startup Mode parameters configured on the Application Settings property sheet to configure which mode, module, and startup user will be active upon entering Run Mode. For this application the PTM panel used with this application is the first Run Mode screen displayed.



Viewing the Monitor Screen

Output offsets are listed on the left side of the Monitor Screen. These are the references that the User Program monitors from Interact. Input offsets are listed on the right side of the screen. These are the references that the User Program writes to Interact.

Notice the Data Error associated with output item #4. You will address this when you are editing the Output List later in this example.

Viewing the User Screen

Now you will go to the screen that was created by the User Program designer.

To view the User Screen, complete this step:

- Click on the **User Screen** button, located in the lower left corner of the screen. The User Screen appears as shown below:

```
TSR TEST PROGRAM          PREDEFINED DATA          14:21:55
OUTPUT ARRAY OFFSETS:
Offset 0 Signed           95
Offset 1 Unsigned         0
Offset 2 Long              0
Offset 3 Float            0.0000
Offset 4 String           DATA ERROR

INPUT ARRAY OFFSETS:
Offset 0 Signed           0
Offset 1 Unsigned         0
Offset 2 Long              0
Offset 3 Float            0.0000
Offset 4 String

Press F1 to change an INPUT offset. Press F2 to switch page.
Press F3 to toggle call-back.
1=UPM, 2=AM, 3=NEXT, 4=PREV, 5=PTH
```

This screen was designed to display the same information as the Monitor Screen. It also allows you to change Input offsets, as you will do in the next step.

Note The Data Error associated with output item #4 is the same one that you saw in the Monitor Screen on Viewing the Monitor Sc. You will address this error later in this example.

Changing the Input Offsets

To change the input offsets, follow these steps:

1. Press **F1**.

The message “Offset to change?” appears.

2. Type **1**; then, press **Enter**.

You are prompted to enter an unsigned integer value.

3. Type **25**; then, press **Enter**.

Notice the new value immediately appears under the Input Array Offset, next to Offset 1 Unsigned. Now you will change the string reference.

4. Press **F1**; then, type **4**.

5. Press **Enter**.

6. At the prompt, type **Message from the User Program**.

7. Press **Enter**.

Notice the string immediately appears under the Input Array Offset, next to Offset 4 String.

Viewing the New Values on the Monitor Screen

To view the new values, complete this step:

- Type **1** to return to the **Monitor Screen**, and observe the effects of your input changes.

Notice that the changes you made on the User Screen are reflected on the Monitor Screen. Under the Input Array Offset, input offset #1 has a value of 25, and input offset #4 displays the first 15 characters of the string.

The first line of the Message Window also displays the ASCII text string of input offset #4. This was configured by setting the address reference of input offset #4 to the link variable `LINK\UPM_WINDOW:A`.

Viewing the PTM Panel

The designer of this example also created a related PTM panel to demonstrate how easily other Interact modules can be incorporated.

To view the PTM panel, follow these steps:

1. On the **Monitor Screen**, click on the **User Screen** button located in the lower left corner of the screen.

The User Screen is displayed.

2. Type **5** to go to the **Panel Toolkit Module (PTM)**.

The example PTM panel appears as shown below:

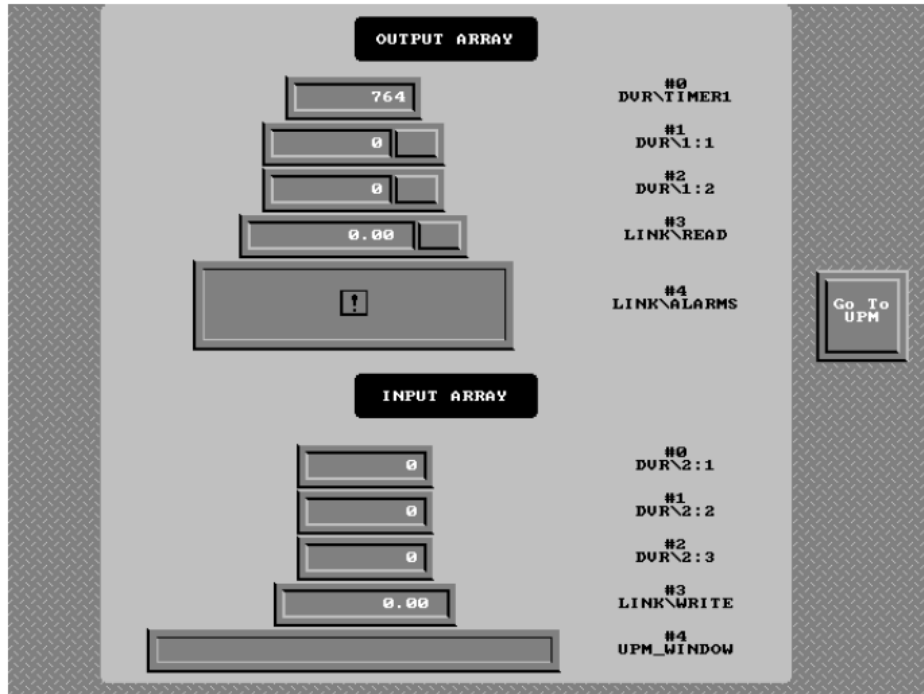

Output offsets and input offsets are listed along with their address references and current values.

Note The Data Error associated with output item #4 is the same one that you saw in the Monitor Screen on Viewing the Monitor Sc and the User Screen on

Viewing the User Sc. You will address this error later in this example.

Modifying the Example Application

In this part of the example, you will do the following:

- Go to UPM in the development environment
- Edit the Output List
- Save the new configuration
- View the results in Run Mode

Returning to the Development Environment

To return to the development environment, follow these steps:

1. From the PTM panel, press **F10** to return to the **Application Manager Main Menu**.
2. Click **Exit Interact**; then, click **Accept**.

The Interact Application Manager window is displayed.

Editing the Output List

In this step, you will edit the configurations of two Output List items.

To edit the Output List, follow these steps:

1. Double-click the **User Program Module (UPM)** icon.
2. Double-click the **Output List** icon.

The Output List window appears as shown below:

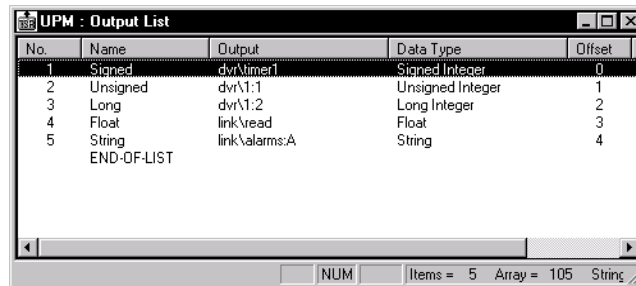

No.	Name	Output	Data Type	Offset
1	Signed	dvr\Timer1	Signed Integer	0
2	Unsigned	dvr\T:1	Unsigned Integer	1
3	Long	dvr\T:2	Long Integer	2
4	Float	link\read	Float	3
5	String	link\alarms:A	String	4
END-OF-LIST				

NUM Items = 5 Array = 105 String

Each output item is listed by number and name, along with its Output Reference, Data Type, Offset, and Block Length. First you will edit item #1 (Offset 0).

Important Notice that item#1 is offset 0. The item number is a location in the list of address references you enter in the development environment. The offset number is the item's actual offset in the User Program's Output (or Input) Array. In Run Mode, the address references are identified solely by offset number.

3. Click anywhere on the row of **item #1**.

The entire row is highlighted.

4. On the **Edit** menu, click **Edit Entry**.

The Output Item dialog box appears as shown below:

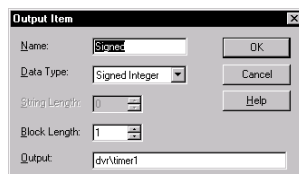

Output Item

Name: OK

Data Type: Cancel

Block Length: Help

Output:

5. Type **Timer1** in the Name box.

6. Click **OK**.

You are returned to the Output List window. Notice that the new name is reflected in the list.

Item #5 (Offset #4) is the reference that caused the errors in the Monitor Screen, User Screen, and PTM Panel. This is because its address reference is LINK\ALARMS:A. This link variable is made available through the Alarm Management Module (AMM) which is not included in Upmexamp.

In the Experiment! section on Experiment!, you are encouraged to add the Alarm Management Module (AMM) to Upmexamp to make this link variable operational. For now, you will change the address reference to make the error disappear.

7. Click anywhere on the row of item #5.

The entire row is highlighted.

8. On the **Edit** menu, click **Edit Entry**.

The Output Item dialog box appears.

9. Type **Timer2** in the Name box.

10. Click on **Unsigned Integer** in the Data Type box.

11. Click in the **Output** box to enter an address reference.

The Address Reference dialog box appears.

12. Delete the current reference, and type **DVR\TIMER2** in the address reference box.

13. Click **OK**.

14. Click **OK** again to accept all of your changes to this Output Item. The Output List window appears where all of your changes are reflected in the list.

15. On the **File** menu, click **Close Module**.

16. Click **Yes**.

The Application Manager window appears.

Testing the Example Application

Now that you have explored the User Program Module (UPM), you are ready to test the application.

Returning to Run Mode

Now, return to Run Mode, and observe the effects of the changes.

To return to Run Mode, follow these steps:

1. From the **Application Browser**, click the **Application Manager** icon.
2. On the **Run** menu, click **Run Interact**.
3. Click **Yes** when you are asked to save changes.

The UPM Monitor screen appears.

Viewing the Modifications

To view the modifications, follow these steps:

1. Click on the **User Screen** button located in the lower left corner of the display.

The User Screen appears. Notice that the changes are reflected and the data error at offset #4 is gone.

2. Type **5**.

The PTM panel appears. Even though the address reference was changed it is still an error on this panel because the change was not made in PTM. This panel is still looking for data from an alarm module.

Experiment! for steps to incorporate an alarm module into Upmexamp.

3. Press **F10** to return to the Application Manager Main Menu.
4. Click **Exit Interact**; then, click **Accept**.

Removing the User Program from Memory

This concludes the UPM example. The TSR User Program will remain in memory until you delete the TSR.EXE entry from your Autoexec.bat file and restart your system.

To remove the TSR from memory, follow these steps:

1. Using a text editor, delete the following line from your Autoexec.bat file:

```
C:\INTERACT\APPPFILES\UPMEXAMP\TSR.EXE
```

2. Save the change, and restart your computer.

A message appears informing you that the TSR has been removed.

Experiment!

This chapter provides only a brief introduction to the features of UPM. The best way to learn is to experiment. Try adding the Alarm Management Module (AMM) to Upmexamp by following the steps below:

1. While in the development environment, add **AMM** to the **Modules Used** list of Upmexamp.
2. Change the configuration of output #5 to its original settings (Data Type = **String**, Output = **LINK\ALARMS:A**).
3. Refer to the AMM help file for information on configuring alarms. For this example, assign a reference of: **DVR\TIMER1 > 200** to trigger an alarm.
4. Add output and input items to the lists in the development environment, and view the results in Run Mode. Note, the example **User Screen** will display only the first five input and output items.
5. Configure the **Master Control** setting (found under **UPM Setup, Triggers**) with the output reference: **DVR\1:10**.
6. Add a **Maintained Push Button** to the PTM panel that specifies this address for its input reference. Notice in Run Mode that the User Program will only receive data when the button is depressed.

You can also read through the TSR.C and TSR.H source code and experiment making changes to the code and compiling.

Interact Network Concepts

Interact includes many features that support Local Area Networks (LANs). These features, when coupled with Interact's existing capabilities, allow you to connect operator interface and supervisory control stations to existing network operating systems, including Novell Netware, Artisoft Lantastic, and Microsoft LAN Manager.

This chapter is intended to describe the possibilities of networking Interact in an existing network environment. Descriptions of how the various Interact modules and drivers can be configured for use in a network environment are presented.

Chapter Contents

<i>Overview of Interact Networking</i>	224
<i>Sharing Data Between Interact Workstations</i>	225
<i>Using Interact DDE Server</i>	227
<i>Application Capabilities Using Modems</i>	228

Overview of Interact Networking

You can use Interact networking to organize, manage, and update your applications more easily. Interact networking products also allow you to turn your plant floor workstation into an information hub, drawing data from the plant floor and sending it to MIS and SCADA environments. You can even use the Interact DDE Server on a PC to collect the factory floor data then use SQL to send the data to a larger system such as an AS400.

Interact networking is designed to work with all NetBIOS compatible networking topologies including Ethernet, Arcnet, and Token Ring. The NetBIOS implementation ensures Interact works with new or existing networks, so Interact networking can be integrated into any manufacturing facility.

Using Interact's network-aware file system, the NetBIOS Driver, the Interact Modem Driver (IMD), and the Interact DDE Server, you can do the following:

- Connect to and share data between Interact workstations
- Transfer data files to remote workstations
- Restart applications at a remote location
- Send new applications to a remote location
- Log data files to a central location
- Run Interact and your Interact applications from a centralized location
- Manage recipes over a network or load recipes from a database
- Send plant floor data to DDE applications in the MIS department
- Use the Interact DDE Server along with SQL to send data to non-PC based systems (i.e. AS400)
- Remotely connect to Interact workstations via a modem

All this capability means Interact not only meets needs ranging from control panel replacement to high supervisory applications, but also can link all these levels together throughout your facility.

Sharing Data Between Interact Workstations

Interact allows plant floor workstations to share data on a LAN. This is done via the Remote Driver Access feature of the NetBIOS driver. Remote Driver Access allows an Interact workstation connected to a network to access information residing in an Interact application running on another station on that network in real-time. Numeric or ASCII data can be written to or acquired from a programmable logic controller (PLC). It can also be read from Interact link variables, for example, to monitor the PLC driver status of a remote station.

All this is done through a simple addressing format. The figure below illustrates a typical address which might be assigned to a PTM tool or alarm used on an application residing on Node_A:

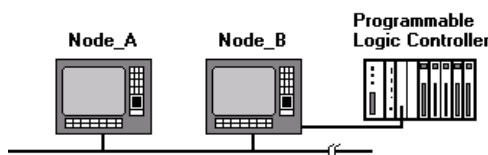

Nbios\Node_B\Dvr\1:1.

In the above example Nbios is used to reference the NetBIOS driver, indicating the data is to be acquired over the network. Node_B is the station on the network from which the data is to be read. The Dvr\1:1 is an address using the Interact demo driver. Replace this with the driver format used in your specific application.

Transferring Data Files and Sending Applications

During Run Mode, Interact Networking allows you to transfer Interact files and applications to and from remote Interact workstations. Typical files might include alarm log files, data logs, recipe logs, and reports. The NetBIOS driver transfer features make it easy to copy files over the network. These transfers may also be security protected.

Interact application files may also be transferred across a network. This makes it possible to create an application at your desk, download it to a remote station on the network, and restart that application.

Logging to and Running Interact from a Central Location

Interact uses many “disk based” files to perform its tasks. Since Interact supports these features and can read and write to its files from any valid location across a network, its file system is said to be “network-aware.” Interact recognizes two DOS runtime environment variables. They are listed below:

- **Interact** - specifies the drive and directory where Interact program files exist.
- **Interact_files** - specifies the drive and directory where application files exist.

These runtime environment variables can be very useful in a networked system for centralizing

all applications and/or program files on a network server.

The network-aware file system also means any path for logging Interact data files may be set to any logical drive on the network. In the following example, a typical alarm log path for Node_A might be **F:\node_a\alarms**. Node_B might store its alarms to the path

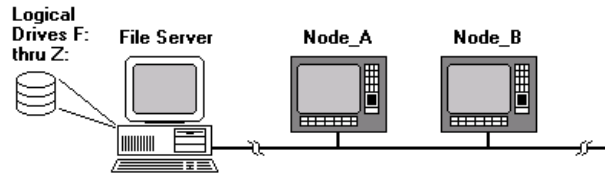

F:\node_b\alarms.

Note The logging and centralized program files are inherent to the Interact software and do *not* require the NetBIOS driver.

Managing Recipes Over a Network

Interact's Recipe Module (RCM) allows you to use different directories to load, save, and delete recipe files in your application. Interact's network-aware file system expands that capability over a network. This means separate workstations on the network can load, save, and delete files from the same locations. This greatly enhances the usability of your recipes by diminishing confusion over which stations hold the most current recipe files.

Using Interact DDE Server

The Interact DDE Server allows you to take plant floor information from an Interact workstation connected to the NetBIOS network and bring that data into any Windows DDE-compatible application.

Interact Gateway Via SQL Environments

Through the Interact DDE Server, data from workstations on the plant floor is brought into Windows DDE-compatible applications. This information can then be manipulated and imported to non-PC based systems (i.e. AS400) or a machine that supports SQL. Thus, Interact allows you to send data to all areas of your organization, from plant floor workstations to higher level database systems.

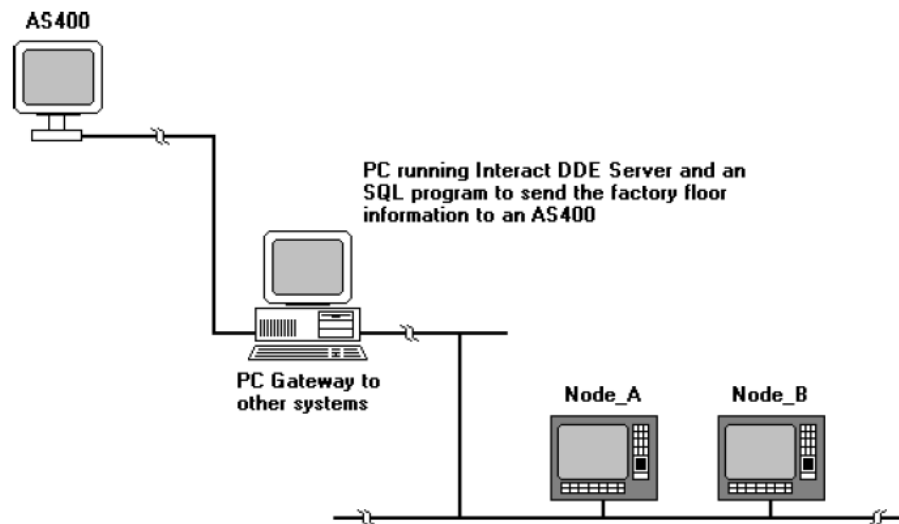

Connecting to SCADA or MIS/MES Environments

During Run Mode, Interact uses the high-speed and efficiency of DOS for plant floor workstations. However, it is important to be able to get that plant floor data to all areas of your organization, like the MIS department.

Many MIS/MES applications require Windows, forcing slower SCADA packages to the factory floor in order to support the needs of the MIS department. This is not where these packages are best suited, since process control requires immediate updates that higher level SCADA packages cannot supply.

The Interact DDE Server allows you to have the best of both worlds. The DDE Server supplies data from an Interact workstation to the Windows environment. In the Windows environment, the DDE Server then supplies that live data to DDE-compatible client applications. DDE client

applications may read from or write to Interact workstation applications.

This relationship is shown below:

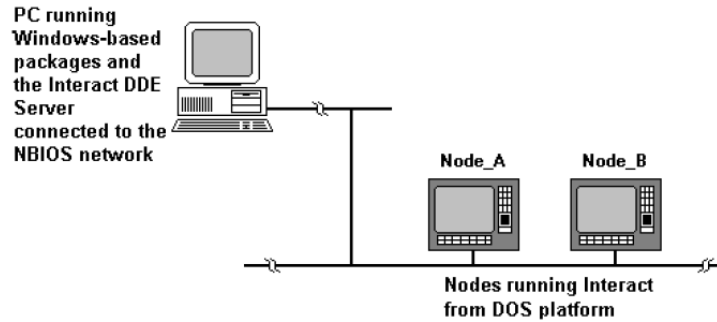

Application Capabilities Using Modems

The Interact Modem Driver (IMD) is used to connect an Interact station to a controller interface (PLC Link) or to connect an Interact station to another Interact station (Network Link). This is shown in the figure below:

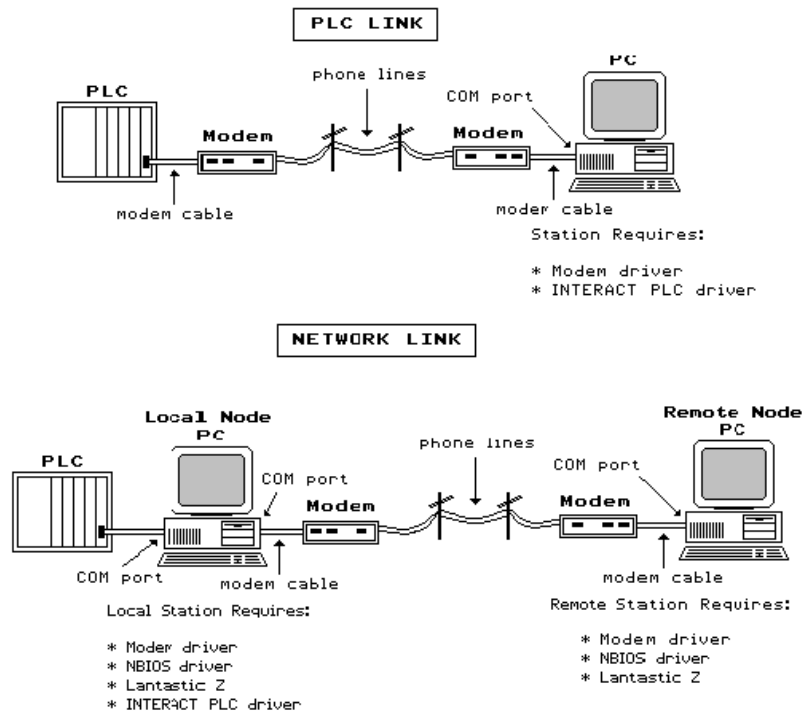

Using
IMD in
direct

a

controller connection (PLC Link) allows an Interact serial driver to connect with a controller via a modem. This modem connection is transparent to the Interact application. It will appear that the application is connected directly to the controller instead of via a modem.

This configuration requires only the use of an Interact serial driver to communicate with the controller. The NetBIOS and LANtastic Z software are not needed in this configuration.

Using IMD in a station-to-station configuration (Network Link) allows one Interact station to connect with another one via modems. This allows the Interact station to have access to data located in the other station by using the Interact NetBIOS Driver. Either node can read or write data locations in controllers connected to the other node.

In this configuration, you must use the following drivers:

- NetBIOS driver
- IMD driver
- LANtastic Z network software

LANtastic Z is a two-node network used to connect two computers via the serial ports. LANtastic Z is a zero-slot network that needs no network adapters.

IMD also includes an automated dialing feature that connects to a remote station based on events, time, or operator inputs. For example, you could have a remote station call a supervisory station when an alarm is triggered, and the supervisory station could then evoke an action to correct the problem.

Frequently Asked Questions

General Interact Questions

1. *Is my CTC hardware Y2K compliant?*

All information on Y2K compliance and necessary upgrades is available on our website.

2. *Does Interact come in any other language?*

Interact development is only available in English.

Configuration Questions

3. *How do I get my application to run on boot-up on my PowerStation?*

You need to adjust settings in Interact development and on the PowerStation. To do this, follow these steps:

- a. In Interact Settings, select your application as the Startup Application.
 - b. Under Application Settings, select the Inhibit AM Menu check box and make sure the startup module is PTM.
 - c. On the PowerStation from the PowerStation Shell main menu, select "Settings", go to "General", select "Power on Operation" and set it to RUN INTERACT.
4. *What internal variable can I use to read and write ASCII?*

The Link Variables are the only internal variables that will accept ASCII data. You must use the suffix ":A" on the link variable to allow the link variable to store ASCII data. For example:

```
LINK\STATE:A = "ON"
```

5. *How do I get my application from my development computer to my Powerstation?*

Use MachineShop, which simplifies the process of transferring projects. See the MachineShop Getting Started Guide for more information.

6. *How do I display alarms in a Remote Message Display tool within Panel Toolkit Module (PTM)?*

When you configure the Remote Message Display tool, put the following Link variable in the Message Text Output field:

LINK\ALARMS : A

Run Time Questions

7. *Where can I get all of the latest drivers for Interact?*

You can download the latest drivers from our FTP site.

8. *I am getting question marks on my Interact tools in run mode after using the Tag Editor. Why?*

You probably did not sort your tag list. Tags in the Tag Editor must be in alphabetical order for Interact to read them properly. Please open up your Tag Editor, go to "Settings" and check the Auto Sort option. With Auto Sort selected, every time you edit your tag list, the list will be automatically sorted.

9. *I need more fonts for my Interact applicaiton. Are any more available?*

Yes, we have a utility called Fontpack. You can have this utility when you join our Product Support Program (PSP). Please contact your local distributor for more information about the PSP program.

Printing Questions

10. *If I want to print graphics from Interact run mode, what do I need?*

You need the correct printer driver in Interact to match your printer. A Printer Drivers Utility program is available. This utility is available to Product Support Program (PSP) members. Please contact your local distributor for more information about the PSP program.

11. *Will my Printer Drivers Utility for Interact version 4.X through Interact version 5.1 work with Interact version 7? No, it will not. Interact 7 has its own Printer Drivers Utility. This utility is available to Product Support Program (PSP) members. Please contact your local distributor for more information about the PSP program.*

